

Forced Convection Heat Transfer From Oscillating Horizontal Cylinder

إنتقال الحرارة بالحمل من إسطوانة أفقية مهتزة

M.A. Shalaby, E.A. Elnegiry, H.R. EL-tahan*

Mechanical Power Engineering Department, Faculty of Engineering,
Mansoura University, Mansoura, Egypt, P. O. Box 35516,

*Workers University, Egypt

الخلاصة:

يستهدف البحث دراسة عملية لتأثير اهتزاز إسطوانة أفقية مسخنة ومعرضة لسريان مستعرض باستخدام الهواء كوسيط على إنتقال الحرارة. إستخدم في المقطع المختبر إسطوانة من النحاس الأصفر قطرها الخارجى 53 mm وطولها 250 mm مسخنة من الداخل بسخان كهربي ومعزولة من نهائيتها، ومحمولة أفقياً من هاتين النهائيتين على تركيبة تستطيع التذبذب رأسياً من خلالها داخل نفق هوائي دون الإتصال المباشر بجسم النفق لتلافي تأثير اهتزاز النفق ذاتة على الأبيوية. وقدمت للدراسة تأثير تردد الاهتزاز اللابعدي Sc ، سعة التذبذب اللابعدي A/D وكذلك تأثير رقم رينولدز Re على إنتقال الحرارة. وتغير رقم Sc من 0.08 حتى 0.45، تغير A/D من 0.037 إلى 0.27 بينما تغير رقم رينولدز Re من 3×10^4 حتى 7.8×10^4 وذلك عن طريق التحكم في سرعة الهواء داخل النفق. وأخذت قيم مختلفة للفيض الحرارى وقد تغيرت من 480 W/m^2 حتى 3000 W/m^2 . وبعد تحليل النتائج العملية ومقارنتها بالحالة الساكنة وجد أن معدل إنتقال الحرارة يزداد بصفة عامة مع زيادة التردد وكذلك مع زيادة سعة التذبذب. وتحدث أكبر زيادة في معدل إنتقال الحرارة عند $Re=3 \times 10^4$, $Sc=0.2$, and $A/D=0.27$ بنسبة حوالى 70% عن الحالة الثابتة. ومن هذه النتائج العملية تم إستنباط معادلة تربط بين رقم نوسلت كدالة في تردد الاهتزاز اللابعدي وسعة التذبذب اللابعدي وكذلك رقم رينولدز بدقة في حدود $\pm 4\%$ عن النتائج العملية.

Abstract

An experimental investigation studies the behavior of heat transferred from a horizontal oscillated cylinder, in case of cross air flow. The investigation studied the effect of dimensionless oscillation frequency (Sc), dimensionless oscillation amplitude (A/D), and Reynolds number on the rate of heat transfer. The oscillated cylinder has 53 mm O.D, the dimensionless oscillation frequency (Sc) of the cylinder is varied from 0.08 to 0.45, while the dimensionless oscillation amplitude (A/D) ranged between 0.037 and 0.27. The Reynolds number is ranged between 3×10^4 and 7.8×10^4 and the rate of heat flux is varied from 480 to 3000 W/m^2 . The test rig of the present work has been examined in the case of stationary cylinder and the obtained results are in a good agreement with the available data in the literature of about $\pm 5\%$, while in the case of oscillating cylinder the rate of heat transfer data indicate a maximum enhancement of about 70% comparing with stationary case at $Sc = 0.2$ and $A/D = 0.27$.

The present data has been correlated in a form of Nusselt number as a function of dimensionless frequency (Sc), dimensionless amplitude (A/D) and Reynolds number (Re) with average deviation of about $\pm 4\%$ relative to the experimental results.

Keywords: Heat transfer; Forced convection; Oscillation

Nomenclatures

A	Amplitude of cylinder oscillation, m	I	Current intensity, Ampere
A_c	Surface area of the cylinder, m^2	k	Coefficient of thermal conductivity, W/m.K
A/D	Dimensionless oscillation amplitude	m, n, z	Exponents in correlation (11)
C	Constant in correlation (11)	\overline{Nu}	Average Nusselt number, $\overline{Nu} = \frac{\overline{h}D}{k}$
C_p	Specific heat, J/kg.K	\overline{Nu}_s	Stationary average Nusselt number
D	Diameter of the cylinder, m		
f	Frequency of oscillation, Hz		
f_n	Natural shedding frequency, Hz		
\overline{h}	Average heat transfer coefficient, $\text{W/m}^2.\text{K}$		

Pr	Prandtl number $Pr = \frac{c_p \mu}{k}$	St	Strouhal number. $St = \frac{f_n D}{U_\infty}$
Q	Heat transfer rate, W	ΔT	Temperature difference, K
Re	Reynolds number, $Re = \frac{U_\infty D}{\nu}$	U_∞	Free-stream velocity, m/s
		V	Voltage drop, Volt.
Sc	Dimension less frequency, $Sc = \frac{f_v D}{U_\infty}$		

Greek Symbols

ν	Kinematics viscosity of fluid, $\nu = \mu / \rho$, m^2/s	θ	Angle of thermocouples, degree
ρ	Density of fluid, kg/m^3	Δ	Difference
α	Thermal diffusivity, $\alpha = k / \rho C_p$, m^2/s	δ	Thickness, m
μ	Absolute viscosity, $kg/m.s$		

Subscripts

∞	Free stream	s	Stationary
a	Ambient air	tef	Teflon
C	Convection	t	Total
l	Losses	v	Vibration

1- Introduction

Heat transfer from oscillating surface is an important technological problem involving many scientifically interesting phenomena. Although it has received considerable attention in recent years. From years ago the possibilities of using oscillation to increase convective heat transfer has received much attention.

Heat exchange between a stationary circular cylinder and its surrounding viscous fluid stream has been a problem of great interest in the past several decades. This problem is frequently encountered in thermal devices such as heat exchangers, nuclear reactors, hot-wire anemometers, etc. Any thermal device during its normal operation will encounter some degree of vibration. The vibration may be generated from the flow itself or from other components in motion. The understanding of the vortex-shedding phenomenon behind the cylinder is one of the fundamental of the fluid-dynamics researchers. The Reynolds number is a dominant parameter governing the flow pattern and the heat transfer characteristics. The vortex pairs appear to periodically shed downstream, and a vortex street is formed in the wake of the cylinder. An important reflection of the complexity of the flow field is the vortex shedding frequency (f_n). Dimensional analysis shows that a dimensionless frequency called Strouhal number (St), which is defined as ($St = f_n \times D / u_\infty$), is essentially a function of Reynolds number. Nevertheless, this number registers a constant value of 0.2 within the value of Reynolds number between 300 to 10^5 [1,2]. A considerable experimental and theoretical researches have been studied the effects of the vibration on the heat transfer characteristics for improving the performance of the thermal devices.

Cheng, et al. [3] studied experimentally the effect of cylinder oscillation on the heat transfer coefficient and flow pattern. They found that the increase in the heat transfer coefficient is about of 34%.

Saxon and Laird [4] described the effect of transverse oscillation on local heat transfer coefficient for a cylinder supported in a vertical position in open water channel during forced oscillations. They found that the amplitude and frequency contributed about equally for increasing the local heat transfer coefficient. An increase in local heat transfer coefficient is about 50 to 60 percent is occurred at the higher frequencies and amplitudes.

Gau, et al. [5] studied experimentally the heat transfer enhancement and vortex flow structure over a heated cylinder oscillating in the cross flow direction. The flow visualization

has been made by using a smoke wire, and local heat transfer is measured around the cylinder. They observed that the higher heat transfer enhancement occurred at the small oscillation amplitude and large excitation frequency. However, at higher Reynolds number or smaller amplitude of the cylinder, the enhancement in the heat transfer becomes less.

Murphy and Lambert [6], studied experimentally the effect of forced transverse vibrations on the local heat transfer coefficient on the heated horizontal cylinder. They found that the vibration causes significant increase in the convective heat transfer from the cylinder, and the maximum Nusselt number occurs at the natural shedding frequency.

Cheng, et al. [7] developed a theoretical model using numerical prediction of convective heat transfer on an oscillating cylinder. The ranges of the variable parameters are as follows; Reynolds number ($0 < Re < 300$), dimensionless oscillation frequency ($0 < Sc < 0.3$), dimensionless oscillation amplitude ($0 < A/D < 0.7$). They found that heat transfer increases with about 13% and the drag coefficient increases from 1.3 to 2.08.

Kimoto, et al. [8] and Dawood, et al. [9], studied experimentally the effect of vertical vibration in natural convection heat transfer from a horizontal cylinder in still air. They observed that the vibration enhances the heat transfer coefficient with about three times by comparison with the stationary case.

Karant, et al. [10], investigated theoretically the effect of cylinder oscillation at the in line and transverse directions on the average Nusselt number. They found that the heat transfer rate from oscillating cylinder increases with the increase of oscillation. The average Nusselt number increases twice at the natural shedding frequency.

Park and Gharib [11], studied experimentally the process of heat transfer from stationary and forced oscillating cylinder in cross flow. They found a large increase in heat transfer rate at a frequency approximately three times the natural vortex shedding frequency.

Pavelek and Iiska [12] studied experimentally the solution of temperature field and the heat transfer coefficient from a horizontal vibrated cylinder under free convection in air. The range of frequencies are from 1.8 to 5.7 Hz and amplitudes are from 0.6 to 2.6 mm. They found that the heat transfer coefficient increases with the increase of frequency and amplitude.

Katinas, et al. [13] investigated experimentally the effect of vibrations on the local and average heat transfer coefficients from a single row tube bundle placed in cross flow. They found that the average heat transfer coefficient increases with the increase of vibration by about 10% greater than that of stationary tube bundle.

Armaly & Madsen [14], and Anantanarayanan & Ramachandran [15], investigated experimentally the effect of vibration on the heat transfer rate by natural convection. They concluded that the increase in either the amplitude or the frequency of the vibration will increase the rate of heat transferred.

Faircloth and Schaetzle [16], investigated experimentally the effect of vibration on the heat transfer coefficient by forced convection. They used chromax wire. The frequency and amplitude of the wire vibration were varied within the ranges of 20 to 40 Hz and 0.3 to 0.5 in, respectively. The results of the investigation revealed that the convection heat transfer coefficient was increased from 20 to 30%.

Penney and Jefferson [17], investigated the effect of the direction of oscillation (vertical or horizontal) on the heat transfer coefficient from horizontal cylinder vibrated at low frequencies and large amplitudes. They observed that the heat transfer coefficient in case of vertical oscillation is greater than the case of horizontal oscillation.

Thrasher & Schaetzle [18], and Lemlich [19], studied the instantaneous heat transfer properties from an oscillating wire in still air. They found that no significant difference noted in the average heat transfer rates for oscillations in the vertical or horizontal planes. The maximum increase was about 400% than that of no vibration.

Abd El Latif et al. [20], Prasad and Ramanathan [21], studied experimentally the effect of longitudinal oscillations on free convective heat transfer from a heated vertical plate. Their results show that the vibration causes a significant increase in steady rate of heat transfer especially at low Rayleigh number. The influence of oscillations diminishes as Rayleigh number increases. The maximum percentage increase varies from 9% to 33%.

Zhao and Cheng [22], Lee, et al. [23], and Kim, et al. [24], studied the numerical solution of laminar forced convection in a heated pipe subjected to a reciprocating flow. They found that the average heat transfer rate increased with both the kinetic Reynolds number and the dimensionless oscillation amplitude.

Lecoite et al., [25], Giffin et al., [26], Hatfield et al. [27], and Giffin et al., [28], studied the effect of vibration on the flow structure in the wake of an oscillating cylinder and drag coefficient. They mainly concluded that the drag coefficient increases with the increase of oscillation frequency.

From the above researches, it is observed that the available data did not cover all regions of Reynolds number and dimensionless frequency and amplitude of oscillation. Therefore, the aim of the present work is to study the behaviour of the heat transferred from a heated horizontal oscillating cylinder in the case of cross air flow as well as in the case of the stationary cylinder. To cover a part of the missing regions, the cylinder used is 53mm in O.D and 250mm in length. The Sc is ranged from 0.08 to 0.45, A/D from 0.037 to 0.27, and Re from 3×10^4 to 7.8×10^4 .

2 Experimental Set-Up

The test rig is constructed to perform the required experiments. Figure(1) shows the layout of this test rig. It mainly consists of:

1- Wind tunnel, 2- Test section, and 3- Vibrator.

2-1 Wind tunnel unit

An open-type wind tunnel is used. Air is drawn by a 6 kW electric blower(3) from a bell mouth inlet(1). The flow rate is controlled by using throttling valve(9). The average velocity of air stream is measured by using a hot-wire anemometer(15). The average air velocity also has been checked by using a pitot static probe(10). The average air stream temperature is measured by two thermocouples inserted in the wind tunnel before the vibrated cylinder. A thermometer is also used to confirm the thermocouple readings.

2-2 Test section and vibrating cylinder

Figure (2) shows test section channel walls (2) which are made of two horizontal transparent perspex plates, and closed by two vertical wooden plates. Two vertical slots are cut in the vertical wooden plates to allow the cylinder oscillate. These slots are covered by the rubber sheet (34) to prevent air leakage and to isolate the wind tunnel vibration out of the test section. Refer to Fig.(2), and Fig.(3), steel frame consists of two units, one of them is used to carry the vibrator unit while the other is used to carry the test section. Each of them is supported in the ground by using stud bolts (33). To absorb the apparatus vibration, rubber washers are placed between the steel structure and the ground. Cam (32) contacts the middle of the steel beam angle (31). The vibrated cylinder is held horizontally by holder bars (29) and attached with the steel beam angle through two springs (30). All latitude members are made of steel angles in order to prevent the deflection which may be occurred by the load effect.

The vibrated cylinder (6) is made of a smooth brass with an inside and outside diameter of 45/53mm respectively, with total length of 250 mm, as shown in Fig.(4). The two ends of the cylinder are sealed with teflon plugs(41). The cylinder is internally heated by using an electric heater coiled on gypsum cylinder(40). Mica sheet (39) is used as an electrical insulation between the heater and vibrated cylinder. Heater power can be changed and measured by using autotransformer and voltmeter-ammeter circuit. The circumferential temperatures have been measured around the vibrated cylinder surface by 28 copper-constant thermocouples of type-T inserted individually with equally spaced in the tube wall. Thermocouples are distributed into three groups as shown in Fig.(5). Four thermocouples are embedded in the teflon plugs with 5mm apart, to check the axial conduction heat loss. Temperature is recorded by using a temperature recorder model (3087) of 0.1°C accuracy.

2-3 Vibrator

The vibrator unit is used to achieve the cylinder oscillation. It consists of the vibration exciter and set of cams. A variable speed 1/3 kW motor (27) is used as the exciter. A variable resistance (18) is used to change the motor speed. The motor is fixed on the steel frame as shown in Fig. (2). The amplitude of vibration changes by using four cams with different eccentricities. The set of cams are made of hard steel disks. Each one is fixed rigidly on the main motor shaft as shown in Fig.(3). In order to prevent wearing due to the friction between the cams and the steel beam angle, cams are pushed in a ball bearing (36). The inner race of the ball bearing is rigidly supported with the cam, while the outer race is in good contact with the steel beam angle, as shown in section A-A Fig.(3). The amplitudes of the oscillation are twice of the eccentric distance, which is pre measured by using a dial-indicator. The velocity of main motor is measured by using a digital strobo scope (11).

3-Test Procedure and Data Reduction

The oscillating cylinder is plugged from its two ends by using two circular teflon plugs of 15mm thick and 56 mm in diameter to minimize the axial heat loss. A heat balance test for the heating cylinder is made for each trial. The axial conduction heat loss (Q_t) from the two teflon plugs is obtained in each run by measuring the temperature difference (ΔT_{tef}) of the two thermocouples in each teflon plug (with thickness $\delta = 5$ mm apart) using equation (3). The maximum axial heat loss was about 4% of the maximum total heat input. The surface temperature of the cylinder is determined by taking the average value of the three sections thermocouples readings over the cylinder surface. The surface temperature fluctuation of the three sections are of about $\pm 3\%$.

So, the rate of heat dissipated from the cylinder surface to air stream by convection (Q_c), can be described as ;

$$Q_c = Q_t - Q_i \quad (1)$$

Where, Q_i is the total heat generated by the heater, defined as;

$$Q_i = I V \quad (2)$$

$$Q_t = \left(\frac{k \Delta T \cdot 2 A}{\delta} \right)_{tef} \quad (3)$$

The average heat transfer coefficient \bar{h} can be calculated as follows:

$$\bar{h} = Q_c / (A_c \Delta T) \quad (4)$$

The heat transfer results for the tested cylinder are represented in terms of average Nusselt number \bar{Nu} , which is defined as :

$$\bar{Nu} = \frac{\bar{h} D}{k_a} \quad (5)$$

Another quantity characterizing the cross air flow around the cylinder is Reynolds number, defined as:

$$Re = \frac{U_\infty D}{\nu_a} \quad (6)$$

The amplitude of oscillation A , is twice the distances between the exciter shaft and the cam center.

4-2-2 Effect of the dimensionless oscillation amplitude, (A/D)

The relationship between the amplitude and the average Nusselt number (\overline{Nu}) at different values of Reynolds number and variable Sc is shown in Fig.(8). Generally, the average Nusselt number increased with the increase of the dimensionless amplitude. Average Nusselt number corresponding to the dimensionless amplitude ranges from 0.037 to 0.189 is slightly increases, while a rapid increase in the average Nusselt number as the dimensionless amplitude increases from 0.189 to 0.27. This occurs because at high values of A/D, the relative velocity between the oscillating cylinder and the fluid flow highly increases. So, at this high relative velocity, the boundary layer of the fluid flow over the oscillating cylinder may be destroyed.

4-2-3 Effect of the Reynolds Number (Re)

Figure (9) a, b, c and d, shows the relation between Nusselt number (\overline{Nu}) and Reynolds number (Re) at constant dimensionless amplitude values of 0.037, 0.113, 0.189, and 0.27 for different values of Sc. It is observed generally that \overline{Nu} increases with the increase of Reynolds number as shown in the figure. The enhancement in Nusselt number (\overline{Nu}) for oscillating cylinder is higher than in the case of stationary one of about 70% as shown in Fig. (9 d). It is also observed that at lower dimensionless amplitude values, heat transfer rate is almost unaffected by the oscillation, but when the cylinder oscillates at a frequency closed to the natural shedding frequency, \overline{Nu} appreciably increased. However, when the cylinder is forced to oscillate at sufficiently high amplitude or frequency the wake of the cylinder may become turbulent.

Figure (10) shows the relation between \overline{Nu} and Re at constant dimensionless oscillation frequency $S_c=0.2$ for different values of A/D for both oscillating cylinder and stationary one. A significant increase in \overline{Nu} for the two cases occurred with the increase of Re . It is observed a rapidly increase of \overline{Nu} in the case of oscillating cylinder than stationary one at Re higher than 5×10^4 .

Figure (11) shows a comparison between the present results and those available in the literature of Cheng et al.[3] using air as a working medium, Park and Gharib [11] using water as a working medium and Gau et al. [5], using air as a working medium, one may observe that the present data shows a good agreement with these available in the literature. In spite of using a higher values of Re with air in the present work than that of using water as coolant mediums by [11], the comparison shows that, $\overline{Nu}/\overline{Nu}_s$ for [11] is higher of about 16% than the corresponding values of the present work.

Finally an attempt is made to correlate the results obtained from the present work. The average Nusselt number is correlated with the other relevant governing parameters, such as dimensionless oscillation frequency, dimensionless oscillation amplitude and Reynolds number. The obtained general correlation is:

$$\overline{Nu} = 0.0704 Re^{0.71} + c Re^n Sc^z (A/D)^m \quad (11)$$

where c, n, m, z, are constants shown in table (1) for different ranges of Sc.

Table (1) Values of constants in equation (11)

condition	c	m	n	z
$0 \leq Sc \leq 0.2$	4.02	0.59	0.58	1.483
$0.2 \leq Sc \leq 0.3$	0.238	0.3313	0.696	-1.955
$0.3 \leq Sc \leq 0.4$	0.987	0.914	0.67	1.928

The maximum relative error recorded between the experimental results and the values obtained by the correlation (11) was about $\pm 4\%$.

Conclusions

The present study is concerned with the forced convection of air flowing over a horizontal oscillating cylinder in vertical direction. The rate of heat transfer enhancement due to the oscillation of the cylinder has been studied. Conclusions coming out of this study are summarized as follows:

- 1- In general the average heat transfer coefficient is significantly increased with oscillation.
- 2- The maximum rate of heat transfer enhancement for oscillating cylinder at $Sc = 0.2$ and $A/D = 0.27$ is about 70% relative to the stationary one.
- 3- The maximum peak of heat transfer rate occurs when the frequency of the cylinder is approximately closed to the natural shedding frequency of the flow, i.e. $f = f_n$. This peak may be repeated with some decay at the values of $f = mf_n$, where $m = 1, 2, 3, \dots$
- 4- The influence of dimensionless oscillations has little effects on heat transfer rate at dimensionless amplitudes less than 0.19.
- 5- A general dimensionless correlation has been obtained in the following form:

$$\bar{N}_u = 0.0704 R_e^{0.71} + c R_e^n S_c^z (A/D)^m$$

References

- 1 John Lienhard IV and John Lienhard V, "A heat transfer text book " Cambridge, Massachusetts, U.S.A. , 2002
- 2 Lienhard, J.H., "Synopsis of lift, drag, and vortex frequency data for rigid circular cylinder". Bull.300, Wash., State Univ., Pullman, 1966.
- 3 Cheng, C.H., Chen, H. N., and Aung, W., "Experimental study of the effect of transverse oscillation on convection heat transfer from a circular cylinder " ASME Journal of Heat Transfer, Vol. 119, pp. 474-482, 1997.
- 4 Saxena ,U. C., and Laird, A. D. K., "Heat transfer from a cylinder oscillating in a cross-flow," ASME Journal of Heat Transfer, Vol. 100, pp. 684-689, 1978.
- 5 Gau, C., Wu , J.M., and Liang , C.Y. , " Heat transfer enhancement and vortex flow structure over a heated cylinder oscillating in the cross-flow direction " ASME Journal of Heat Transfer, vol. 121, pp. 789-795, 1999.
- 6 Murphy, K.D. and Lambert , T.A., " Model effect on the local heat transfer characteristic of vibrating body " ASME Journal of Heat Transfer, vol. 122, pp. 233-239, 2000.
- 7 Cheng, C.H., Hong, J.L., and Aung, W, " Numerical prediction of lock-on effect on convective heat transfer from a transversely oscillating circular cylinder," Int. Journal Heat Mass Transfer, Vol. 40, pp. 1825-1834, 1997.
- 8 Kimoto, H., Kadotsuji, A. and Hirose, T. " Effect of vibration on the natural convection heat transfer of a horizontal cylinder " JSME, vol. 26, No. 217, July 1983.
- 9 Dawood, A.S , Manocha , B. L and Ali, S.M.J., " The effect of vertical vibrations on natural convection heat transfer from a horizontal cylinder " ASME Journal of Heat Transfer, vol. 92, pp. 491-496, 1981.
- 10 Karanth , D., Rankin, G.W., and Sridhar,K., "A finite difference calculation of forced convection heat transfer from an oscillating cylinder," Int. Journal Heat Mass Transfer, Vol.37. pp.1619-1630, 1994.
- 11 Park, H.G., Gharib, M., "Experimental study of the heat convection from stationary

- and oscillating circular cylinder in cross flow " ASME Journal of Heat Transfer, vol. 123, pp. 51-62, 2001.
- 12 Pavelek, M. and Liska, M. "A study of heat transfer from a horizontal cylinder by means of holographic interferometry" <http://dt.fme.vutbr.cz/~Pavelek/pav4.htm>.
 - 13 Katinas, V.I., Markevicius, A.A. and Zukauskas, A.A., " Heat transfer behavior of vibrating tubes operating in cross flow " Heat transfer Soviet research, vol. 18, No. 2, April 1986.
 - 14 Armaly, B.F., and Madsen, D.H., "Heat transfer from an oscillating horizontal wire," ASME Journal of Heat Transfer, Vol.93, pp.239-240, 1971.
 - 15 Anatanarayanan, R., and Ramachandran, A. , "Effect of vibration on heat transfer from a wire to air in parallel flow," ASME Journal of Heat Transfer, vol. 80, pp. 1426-1432, 1958.
 - 16 Faircloth , J.M., and Schaetzle, W.J., "Effect of vibration on heat transfer for flow normal to a cylinder " ASME Journal of Heat Transfer, vol. 91, pp. 140-144, 1969.
 - 17 Penney, W.R. and Jefferson, T.B., " Heat transfer from an oscillating horizontal wire to water and ethylene glycol " ASME journal of Heat Transfer, vol. 88, pp. 359-366, 1966.
 - 18 Thrasher, B. H., and Schaetzle, W.J., "Instantaneous measurement of heat transfer from an oscillating wire in free convection", ASME Journal of Heat Transfer , vol 92, pp. 439-445, 1970.
 - 19 Lemlich, "Effect of vibration natural convection heat transfer" Industrial and Engineering Chemistry, Vol. 47,pp 1175-1180, 1955
 - 20 Abdel Latif, O.E, El-Ghnam, R.I and Ali, M., "Experimental Study of the effect of longitudinal oscillations on free convection from a heated vertical plate" Al-Azhar Engineering sixth international conference, September 2000.
 - 21 Parsad, K. K. and Ramanathan, V. " Heat transfer by free convection from a longitudinally vibrating vertical plate " Int. Journal Heat Mass Transfer, Vol. 15, pp. 1213-1223, 1972.
 - 22 Zhao, T. and Cheng, P., "A numerical solution of laminar forced convection in a heated pipe subjected to reciprocating flow " Int. Journal Heat Mass Transfer ,Vol.38, No. 16, pp. 3011-3022, 1995.
 - 23 Lee, D. Y., Park, S. J. and Tack ,S., "Heat transfer by oscillating flow in a circular pipe with a sinusoidal wall temperature distribution" Int. Journal Heat Mass Transfer, Vol. 38, No. 14, pp. 2529 -2537, 1995.
 - 24 Kim, S.Y, Kang, B.H and Hyun, J.M., " Heat transfer in the thermally developing region of a pulsating flow " Int. Journal Heat Mass Transfer, Vol. 36, No. 17, pp. 4257-4266, 1993.
 - 25 Lecointe, Y. and Piquet, J., " Flow structure in the wake of an oscillating cylinder " Journal Fluid Mech., Vol. 111, pp. 139 -148, 1989.
 - 26 Giffin, O. M. , and Raamberg, S. E., " Vortex shedding from a cylinder vibrating in line with an incident uniform flow " Journal Fluid Mech.,Vol. 75, pp. 257 -271, 1976.
 - 27 Hatfield, H. M. ,and Morkovin, M. V., "Effect of an oscillating free stream on the unsteady pressure on a circular cylinder " ASME Journal of Fluid Engineering, Vol. 95, pp. 249- 254, 1973.
 - 28 Griffin, O.M ,and Hall, M.S., " Review-vortex shedding lock-on and flow control in bluff body wakes " ASME Journal of Fluids Engineering, Vol. 113, pp. 526-537, 1991.
 - 29 McAdams, W.h., "Heat Transmission" 3rd edition, McGraw-Hill, New York, 1954.
 - 30 Eckert, E. R. G.,and R. M. Drake,"Analysis of Heat and Mass Transfer,"McGraw-Hill Book Company, New York, 1972.

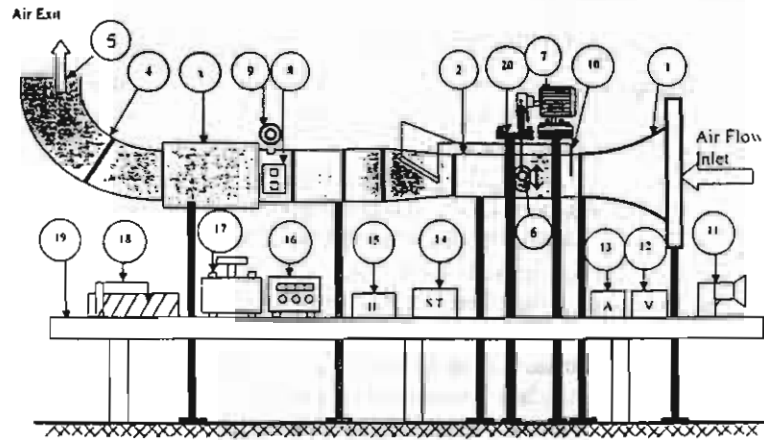

Fig. (1) Test rig

- | | | | |
|----------------------|-----------------------|-------------------------|--------------------------|
| 1. Air flow inlet | 6. Vibrating cylinder | 11. Strobe-scope | 16. Temperature recorder |
| 2. Test section duct | 7. Vibrating unit | 12. Voltmeter | 17. Auto-transformer |
| 3. Blower | 8. On-off switch | 13. Ameter | 18. Variable resistance |
| 4. Elbow | 9. Throttle gate | 14. Stabilizer | 19. Table |
| 5. Air exit | 10. Pilot tube | 15. Hot wire anemometer | 20. Steel frame |

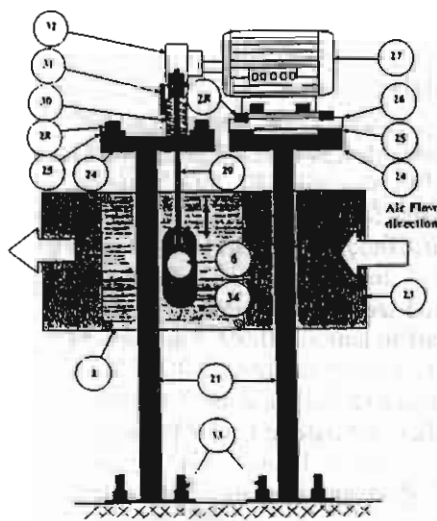

Fig. (2) Test section

- | | | |
|----------------------|--------------------|------------------------|
| 2. Test section | 26. Wooden plate | 31. Reciprocating beam |
| 6. Vibrated cylinder | 27. Electric motor | 32. Cam |
| 21. Steel frames | 28. Bolts | 33. Studs |
| 23. Wind tunnel | 29. Steel stem | 34. Rubber sheet |
| 24, 25 Steel angles | 30. Springs | |

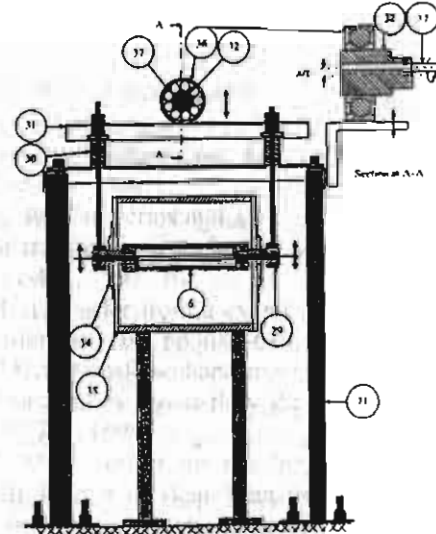

Fig. (3) Face elevation of the test section

- | | | |
|-----------------------|------------------------|------------------|
| 6. Vibration cylinder | 31. Reciprocating beam | 36. Ball bearing |
| 21. Steel frame | 32. Cam | 37. Motor shaft |
| 29. Holder bar | 34. Rubber sheet | |
| 38. Springs | 35. Wood plates | |

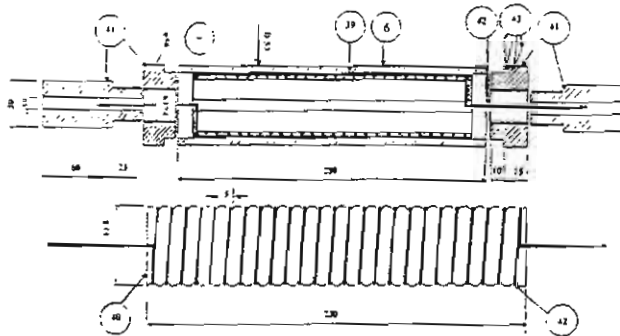
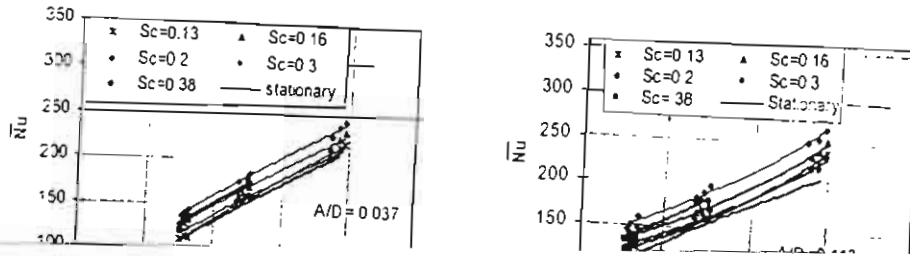

Fig. (4) Vibrating cylinder details

6. Vibrated cylinder, 40 Gypsum threaded cylinder, 42. Heater (Nical-chrom) coil
 39. Mica sheet, 41. Teflon plugs, 43. Thermocouples.

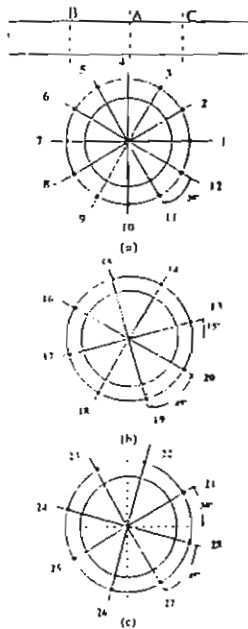

Fig. (5) Distribution of the thermocouples probes on the cylinder, (a) at the middle of the tube, (b) at the left end, and (c) at the right end.

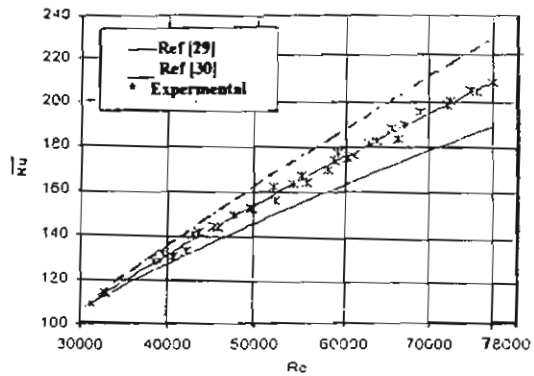

Fig. (6) Average Nusselt number of stationary cylinder versus Reynolds number of the present work compared with others.

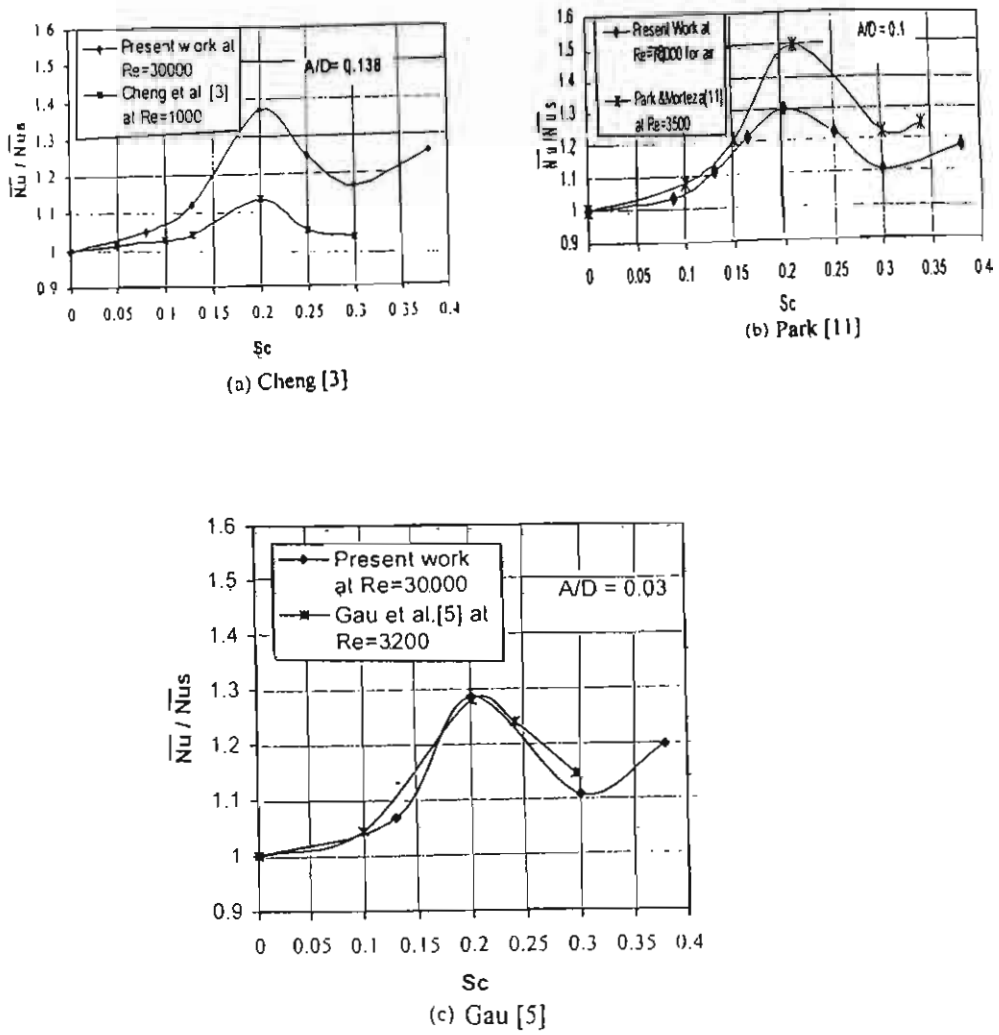

Fig. (11) Relative Nusselt number versus dimensionless Oscillation frequency of the present work compared with others.

Fig. (12) Variation of the average Nusselt number with amplitude under different values of dimensionless frequency.