

Experimental Investigation of Heat and Mass Transfer in Evaporative Heat Exchangers at Variable Operating Conditions

Mostafa A. Abdel-Baky¹, Amr Ibrahim M. Eid² and Hany. A. Shalata³

1 Ass. Prof., Faculty of Engineering, Menoufia University, Egypt.

2 Lecturer, Faculty of Industrial Education, Helwan University, Egypt.

3- Teacher in the Industrial Secondary Education, Menoufia, Egypt.

ABSTRACT

The evaporative heat exchanger has numerous applications in transferring heat. In this research an experimental study of the heat and mass transfer has been conducted on an experimental evaporative heat exchanger. The study involves the effect of cold water mass flow rate, hot water inlet temperature, air flow rate, injection holes diameter and horizontal distance between injection holes on the heat transfer, overall heat transfer coefficient, effectiveness and mass transfer. The results obtained indicate an increase of heat and mass transfer with the increase of hot water flow rate, hot water inlet temperature, air flow rate and injection holes diameter.

التحقيق التجريبي لبعض العوامل المؤثرة على إنتقال الحرارة والكتلة في المبادلات الحرارية التبخرية عند ظروف تشغيل مختلفة.

ملخص البحث:

للمبادل الحراري التبخيري العديد من التطبيقات في نقل الحرارة. في هذا البحث تم إجراء دراسة تجريبية لبعض العوامل المؤثرة على إنتقال الحرارة والكتلة في المبادل الحراري التبخيري. اشتمل البحث علي دراسة تأثير كل من معدل تصرف الماء البارد، درجة حرارة دخول الماء الساخن، معدل تصرف الهواء، قطر الرشاشات والمسافة الأفقية بين الرشاشات علي كل من انتقال الحرارة، المعامل الكلي لانتقال الحرارة، فعالية المبادل الحراري و انتقال الكتلة. وقد أوضحت الدراسة زيادة معدل انتقال الحرارة والكتلة مع زيادة كل من معدل تصرف الماء الساخن ودرجة حرارة دخول الماء الساخن ومعدل تصرف الهواء وكذلك قطر الرشاشات.

Keywords: Heat transfer, Evaporative heat exchanger, Evaporative condenser.

1- INTRODUCTION

Heat exchanger is a device that transfers heat between two or more spaces or substances. It is classified into many types. One type is the evaporative heat exchanger. An evaporative heat exchanger is a combination of cooling tower and heat exchanger. The purpose of that device is to such fluid by water in the same time water is cooled by direct contact with air. To achieve this process water is sprayed in a tower on the outer surface of the heat exchanger to cool it. The sprayed water becomes hot. Air is blown and come in contact with the falling water. Some of sprayed water evaporates and carried out with air while the temperature of the rest gets down. The cooled water falls down in the tower basin where it is pumped again to the spray tube.

An application of the evaporative heat exchanger is the evaporative condenser which mainly used in refrigeration systems that has high cooling capacity. The use of evaporative processes to improve vapor compression system cooling efficiency is an important method for reducing energy use and peak demand in hot-dry climates. Evaporative condensers

demonstrate efficiency advantages by reducing the temperature of the condensing environment from the outdoor dry bulb temperature to close to the outdoor wet bulb temperature. Their efficiency is essentially unaffected by high ambient temperatures in dry climates and indoor comfort is not compromised in humid conditions in contrast to evaporative coolers. The impact is most significant during utility peak periods when the difference between dry and wet bulb temperatures is often greatest.

The evaporative heat exchanger has many benefits. Using of it as a condenser in a refrigeration system minimize the volume of the condenser compared to the air cooled one. The condenser pressure of refrigeration system also decreases which in turn leading to a decrease in the power consumption. Besides, the refrigerating effect increases and consequently the system cooling capacity increase.

Many efforts have been conducted to study heat and mass transfer as well as the effectiveness of evaporative heat exchanger. Webb and Villacres [1] developed a computer program to predict the performance of evaporative heat exchanger under

virtually any operating condition of interest. Rana et al [2] investigated the heat transfer coefficient from the outer surface of a horizontal tube subjected to water spray without air flow. They also studied the heat and mass transfer from the same tube in case of air flow opposite to the sprayed water and the results obtained were compared with that of the case without air flow. Backman et al [3] studied the use of evaporative processes to improve vapor compression system cooling efficiency. Their results indicated a decrease of condenser effectiveness when the wet bulb temperature of air was decreased.

Heat, mass transfer and fluid flow characteristics in evaporative condensers were investigated by Bykov et al [4]. They indicated that the spray-filled space underneath the coil had a substantial effect on heat rejection. On the other hand, the effect of the upper spray nozzle zone is insignificant so that it was not recommended to add heat and mass transfer surfaces in the upper portions of the condenser. Zalewski [5] formulated a mathematical model for predicting heat and mass transfer in evaporative condenser at steady state condition. Radojković et al [6] investigated experimentally the influence of tube bundle witting on the heat transfer intensity in evaporative heat exchanger. They indicated that, the heat exchange increased with the increasing either of water spreading density over the tube bundle or air flow. The performance of two evaporatively cooled heat exchangers is investigated under similar operating conditions of air flow rates and inlet hot water temperatures by Hasan and Siren [7]. Their model was used to calculate the thermal performance of the plain and finned tubes assuming a constant spray water temperature in the heat exchanger. The wet-finned surfaces show low fin efficiency compared with dry surfaces.

Performance evaluations of refrigeration system were studied by Hosoz and Kilicarslan [8]. They compared the performance characteristics of refrigeration system employing three types of condensers, namely the air-cooled, the water-cooled and the evaporative condensers. The experimental studying, that conducted in the same vapor compression refrigeration unit operating with a different condenser in each test, indicates higher C.O.P for the evaporative condenser than that for air cooled condenser. Rajneesh and Kumar [9, 10, 11] studied experimentally the heat flux and mass transfer coefficient over the surface of a tube of evaporative tubular heat dissipator during falling film on a horizontal tube of an evaporative tubular through which hot water was flowing. It was indicated that evaporative effectiveness and mass transfer coefficient increased as the cooling water film flow rate was increased and air flow rate was constant. Ivoni et al [12] found in their experimental analysis

of an evaporative condenser that, the condensation temperature was influenced by the humidity ratio and enthalpy changes of the moisture air. Greater condensation temperatures led to decrease the performance coefficient of the refrigeration cycle in which that equipment often works at lower wet bulb temperatures.

Wei et al [13] indicated in their analysis of evaporative condenser for steam power plant that, the condensing temperature of the steam in the tube was increased with the increasing of air and water film temperatures. The condensing temperature of the steam was decreased with the increasing of water flow rate and the wind velocity. The evaporation capacity of the water outside the tube was increased with the increasing wind velocity. Ettouney et al [14] conducted an experimental investigation to study the performance of evaporative condensers. The analysis included development of correlations for the external heat transfer coefficient and the system efficiency. The analysis was performed as a function of the water-to-air mass flow rate ratio and the steam temperature. The analysis showed that the system efficiency was increased at lower water to air mass flow rate ratios and higher steam temperatures.

Evaporative effectiveness and mass transfer coefficient of a U-shape brass tube of an evaporative heat exchanger was studied by Duhan and Kumar [15]. It was reported that the increase in evaporative effectiveness was found with slight stagnation with increase of Reynolds number of water and Reynolds number of air. Evaporative effectiveness and mass transfer coefficient were decreasing with the increase of dimensionless enthalpy potential. Chander and Singh [16] studied experimentally the effect of dry out heat flux and mass transfer coefficient on a single horizontal copper tube of an evaporative tubular heat dissipate. It was found that, for the case of only water flow, the onset and permanent dry out heat flux was increased with the increase of Reynolds number of water. In case of both water and air flow it was observed that dry patches occurred on the surface of the tube when Reynolds number of air was increased. At higher flow of cooling water there was no dry patches formed on the surface of the tube.

The review of the previous work has no studying of hot water flow rates, the effect of injection holes diameter and using cover sheet on the heat and mass transfer. Besides, the cold water flow rate was taken based on low Reynolds number.

2- Experimental Study:

The experimental apparatus was designed and constructed as shown with its all details in Fig. 1. Hot water is supplied from a tank of 50×50 ×50 cm. The tank was made of steel of 4 mm thickness and it is

fixed on a steel frame stand. The tank is equipped with two electric heating coils of 1.5 kW each. The coils were supplied with thermostat to maintain constant temperature. The hot water was taken from the tank at a high level. After passing through the heat exchanger, the hot water was returned to the tank by a centrifugal pump of 0.37 kW power. The heat exchanger was made of copper tube, type K, of inner and outer diameters of 1.02 and 1.27 cm respectively. The horizontal length of the coil is 80 cm and its height is 81 cm. Hot water, used to be cooled, flows under gravity effect from the heating tank to the coil through a rubber tube of 1.6 cm inner diameter and 2.3 cm outer diameter. The rubber tube and the coil were connected together, through another rubber tube of inner and outer diameters of 1.25 cm and 1.6 cm respectively. At the end of the coil, water is extracted by the pump where it is discharged to the heating tank.

The required flow rate was adjusted by the aid of a valve and a Rota meter. The front and back sides of the outer case of the heat exchanger were made of acrylic while the two sides were made of steel. An air blower was installed at the bottom of front side for supplying the required air.

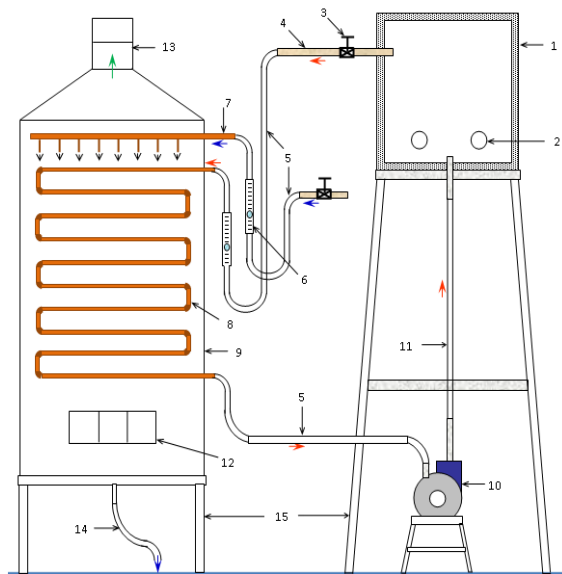

- 1- Isolated hot water tank.
- 2- Electric heart.
- 3- Control valve.
- 4- Steel tube.
- 5- Rubber tube.
- 6- Flow-meter.
- 7- Cold water sprays tube.
- 8- Hot water coil.
- 9- Tower.
- 10- Pump.
- 11- Hot water return tube
- 12- Inlet air fan connection.
- 13- Exhaust air duct.
- 14- Cold water drain tube.
- 15- Stand Frame.

Fig. 1 Experimental apparatus details

Cold water was taken from the main supply net and injected at the top of the middle section of the heat

exchanger case through capillary tubes. Capillary tubes were welded with the injection tube to ensure good film cooling to the hot coil and the required distance between the injection holes and vertical distance between the holes and hot coil are adjusted. Each of hot and cold water coils was made of copper tube of type "K" with inner and outer diameters of 1.656 and 1.905 cm respectively.. Six injection cold water models were chosen. As shown in table (1).

Table (1): Summary of the injection models.

Distance	Injection hole diameters [mm]		
	d ₁	d ₂	d ₃
5 cm apart	0.79	1.39	1.78
10 cm apart	0.79	1.39	1.78

The temperature of hot and cold water was measured at the inlet and outlet of each coil with the aid of calibrated copper constantan thermocouples. The output of the thermocouples was reading by calibrated digital indicator. The inlet and outlet temperature and relative humidity of air were measured by two calibrated humidifiers. The air velocity was measured at air outlet by the aid of portable hot wire.

3- Results and Discussions:

The effectiveness of evaporative heat exchanger is affected by many parameters such as; the flow rate and inlet temperature of each of hot water, cold water and air, these parameters affect each of heat dissipated from the hot-water coil, overall heat transfer coefficient, the effectiveness and mass transfer of the experimental evaporative heat exchanger.

3-1 Effect of hot water flow rate:

The effect of hot water flow rate on each of heat dissipated from the hot water coil, overall heat transfer coefficient, effectiveness and mass transfer of the experimental evaporative heat exchanger was studied at cold water Reynolds number of 3585, 4062, 4702, 5019 and 5438. This effect was conducted at hot water inlet temperature of 80 °C, injection holes diameter of the cold water was 0.79 mm, the interval distance between the injections of the cold water was 50 mm, the height between the injections of the cold water and the first row of the hot water coil was 40 mm and the air mass flow rate was 0.02 kg/sec.

The heat dissipated from hot water could be calculated from Eq. (1) as:

$$\dot{Q}_h = \dot{m}_h C_{p_w} (T_{h,i} - T_{h,o}) \quad (1)$$

Where: \dot{m}_h the mass flow rate of hot water.

C_{p_w} : is the specific heat of water.

$T_{h,i}, T_{h,o}$: inlet and outlet hot water temperature.

The Reynolds number could be calculated as:

$$Re = \frac{\rho C d_i}{\mu} = \frac{4 \dot{m}}{\pi d_i \mu} \quad (2)$$

Where: ρ the water density.

d_i : tube inlet diameter.

C : fluid velocity.

μ : dynamic viscosity.

Figure (2) shows the effect of hot water flow rate on the heat dissipated for different cold-water flow rates. It is seen that, the heat dissipated from the hot water coil is increased with the increase of hot water flow rate. As example for the case of cold water Reynolds number of 5438, the heat transfer is increased from 8.16 to 9.97 kW with a percentage increase of 22.18 when the hot water Reynolds number is increased from 22629 to 31439 with a percentage increase of 38.93. This explained as indicated in Eq. (1) as the heat transfer is function of mass flow rate.

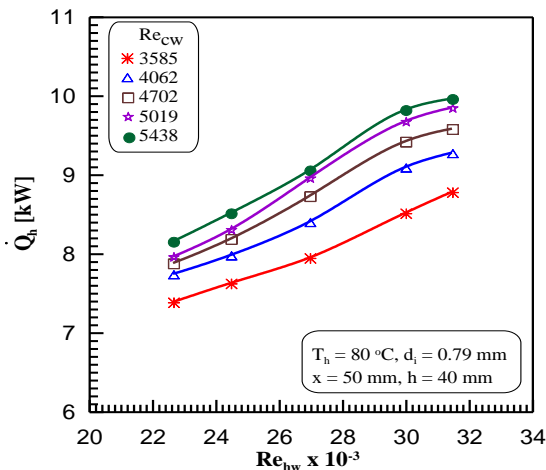

Fig. 2 Effect of hot water flow rates on the heat dissipated for different cold-water flow rates.

The overall heat transfer coefficient (U) could be calculated as the following:

$$\dot{Q}_h = U_o A_o \Theta_m \quad (3)$$

Where: $A_o = \pi d_o L$, Θ_m could be obtained as follows:

$$\Theta_m = \frac{(T_{h1} - T_{c1}) - (T_{h2} - T_{c2})}{\ln\left(\frac{T_{h1} - T_{c1}}{T_{h2} - T_{c2}}\right)} \quad (4)$$

Equation (3) indicates that, the overall heat transfer coefficient increases with the increase of heat transfer. This is indicated in Fig. 3 which illustrates the effect of hot water flow rate on the overall heat transfer coefficient of the hot water coil. The figure indicates that, the overall heat transfer coefficient from the hot water coil is increased with the increase of hot water flow rate. As example for the case of cold water Reynolds number of 5438, the overall heat transfer coefficient is increased from 799 to 926 $W/m^2.K$ with a percentage increase of 15.9 when the hot water Reynolds number is increased from 22629 to 31439 with a percentage increase of 38.93.

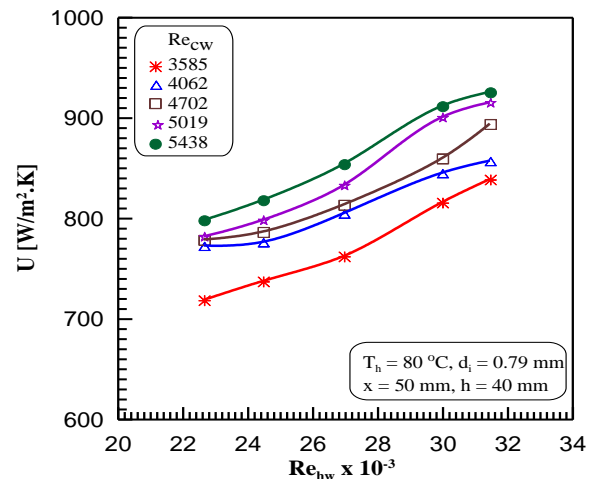

Fig. 3 Effect of hot water flow rates on overall heat transfer coefficient for different cold-water flow rates.

The effectiveness (ϵ) of the heat exchanger is an important factor in heat transfer devices. This factor indicates how much of useful heat transfer from the available heat. This factor could be calculated as following, See Fig. (4):

$$\epsilon = \frac{\text{Actual heat loss}}{\text{Max. available}} = \frac{(T_{h,i} - T_{h,o})}{(T_{h,i} - T_{c,o})} \quad (5)$$

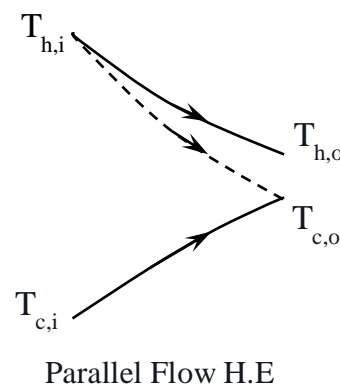

Fig. 4 Temperature gradient for Parallel flow heat exchanger

Figure 5 shows the effect of hot-water flow rate on the effectiveness of the evaporative heat exchanger for different cold water flow rates. The effectiveness of the evaporative heat exchanger increases as the hot water flow rate is increased. For the case of cold water Reynolds number 5438, the effectiveness of the experimental heat exchanger is decreased from 0.49 to 0.43 with a percentage decrease of 12.24 when the hot water Reynolds number is increased from 22629 to 31439 with a percentage increase of 38.93.

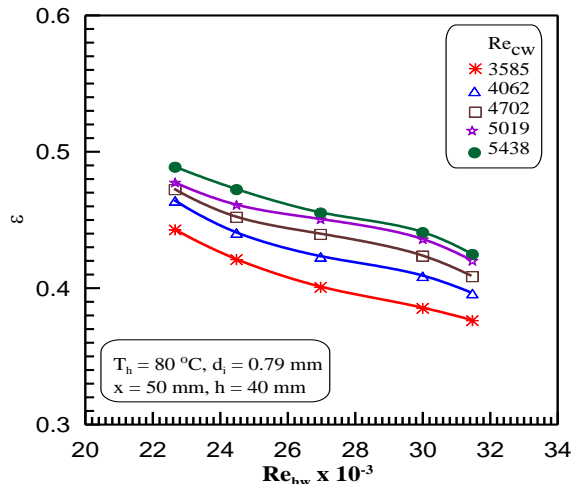

Fig. 5 Effect of hot water Reynolds number on heat-exchanger effectiveness for different cold-water Reynolds number

The decrease of heat exchanger effectiveness could be explained as the increase of hot water flow rate causes high velocity. Accordingly, the time of heat transfer is decreased which in turn causes an increase on the hot water temperature along the heat exchanger path. This results in high temperature at the exit for the hot water. This means that energy go out from the heat exchanger thus the effectiveness of the experimental evaporative heat exchanger is decreased.

In evaporative heat exchangers some of sprayed water may vaporized and carried out by the air. Make up water is required instead of this vaporized water. The amount of water vapor could be obtained by the following relation:

$$\dot{m}_v = \dot{m}_a (\omega_2 - \omega_1) \quad (6)$$

$$\dot{m} = \rho AC \quad (7)$$

Where: A is the cross section area of air outlet opening; C is the average air velocity. ω_1 and ω_2 are the humidity ratio obtained at air inlet and outlet conditions from psychrometric chart as shown in Fig. 6.

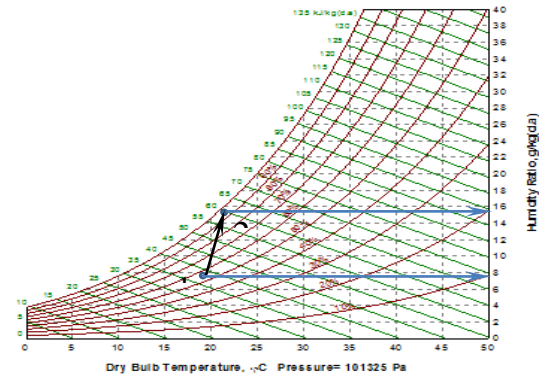

Fig. 6. Representation of air conditions process on psychrometric chart

Figure 7 illustrated the mass transfer of the evaporative heat exchanger as a function of hot-water flow rate for different cold-water flow rates. The figure indicates that, as the increase of hot water flow rate, the heat transfer increases as indicated before and consequently more vaporization occurs and the specific humidity of air increases.

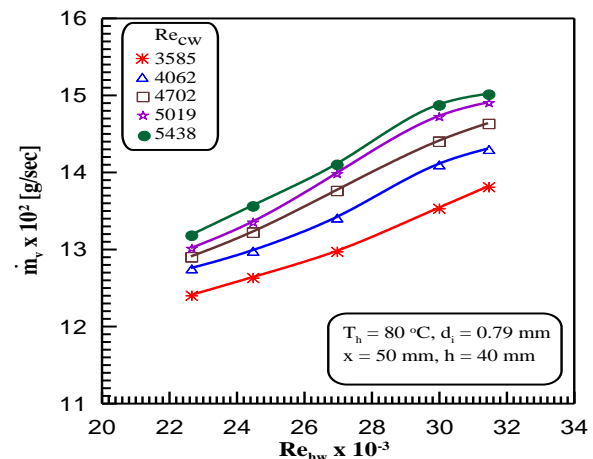

Fig. 7 Effect of hot water Reynolds number on mass transfer for different cold-water Reynolds number

This means that the mass transfer increases with the increase of cold water flow rate. For the case of cold water Reynolds number 5438, the mass transfer of the evaporative heat exchanger is increased from 0.138 to 0.15 g/sec with a percentage increase of 8.69 as the Reynolds number of hot water is increased from 22629 to 31439 with a percentage increase of 38.93.

This means that the mass transfer increases with the increase of cold water flow rate. For the case of cold water Reynolds number 5438, the mass transfer of the evaporative heat exchanger is increased from 0.138 to 0.15 g/sec with a percentage increase of 8.69 as the Reynolds number of hot water is increased from 22629 to 31439 with a percentage increase of 38.93.

3-2 Effect of cold water flow rate:

The effect of cold-water flow rate on each of heat dissipated from the hot water coil, overall heat transfer coefficient, the effectiveness and mass transfer of the experimental evaporative heat exchanger was studied at Reynolds number of 3585, 4062, 4702, 5019 and 5438. This effect was conducted at hot water inlet temperature of 80 °C, injection holes diameter of the cold water was 0.79 mm, the interval distance between the injections of the cold water was 50 mm, the height between the injections of the cold water and the first row of the hot water coil was 40 mm and the air mass flow rate was 0.02 kg/sec.

Figure 8 shows the effect of cold water flow rates on the heat dissipated from the hot water as for different hot water flow rates. The heat dissipated from the hot water coil is increased as the cold-water flow rate is increased. This result is expected, as the experimental setup is a heat exchanger.

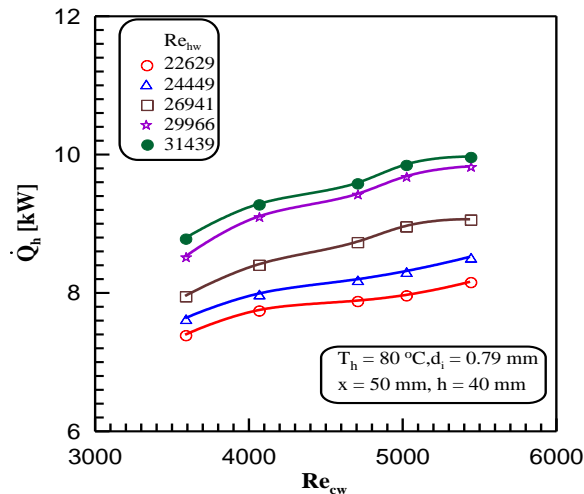

Fig. 8 Effect of cold-water flow rates on heat dissipated for different hot water Reynolds number. For the case of hot water Reynolds number 31439, the heat dissipated is increased from 8.79 kW to 9.97 kW as the Reynolds number of cold water is increased from 3585 to 5438. Therefore, there is 13.42 % increasing in the heat dissipated from the hot water as the Reynolds number of cold water is increased by 51.69 %. The increasing of cold-water flow rate decreases the cold-water temperature along the heat exchanger path, which results in high temperature difference between the two streams, so the heat exchange is increased.

The overall heat transfer coefficient from the hot water coil as a function of cold water flow rate for different hot water flow rates is illustrated in Fig. 9.

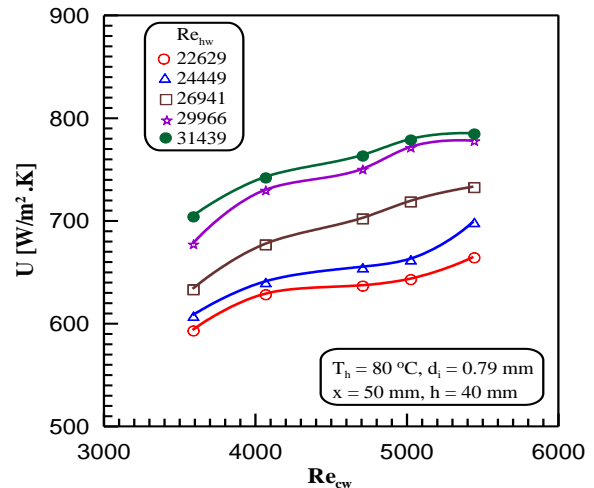

Fig. 9 Effect of cold water Reynolds number on overall heat transfer coefficient for different hot water Reynolds number.

It is indicated that, the overall heat transfer coefficient from the hot water coil is increased with the increase of cold-water flow rate. For the case of hot water Reynolds number 31439, the overall heat transfer coefficient from the hot water coil is increased from 704 to 785 W/m².K as the Reynolds number of cold water is increased from 3585 to 5438. Therefore, there is an increase of 11.51 % in the overall heat transfer coefficient from the hot water coil as the Reynolds number of cold water is increased by 51.69 %. The increasing of cold-water flow rate decreases the cold-water temperature along the heat exchanger path, which results high temperature difference between the two streams. So, the overall heat transfer coefficient for the hot water coil is increased.

Figure 10 shows the effectiveness of the evaporative heat exchanger as a function of cold Reynolds number for different hot water flow rates. The effectiveness of the evaporative heat exchanger increases as the cold-water Reynolds number increases. For the case of hot water Reynolds number 31439, the effectiveness of the evaporative heat exchanger is increased from 0.38 to 0.43 as the Reynolds number of cold water is increased from 3585 to 5438. Therefore, there is 13.16 % increasing in the effectiveness of the evaporative heat exchanger as the Reynolds number of cold water increasing by 51.68 %. The increasing of cold-water flow rate decreases the cold-water temperature along the heat exchanger path, which results high temperature difference between the two streams, so the effectiveness of the evaporative heat exchanger is increased.

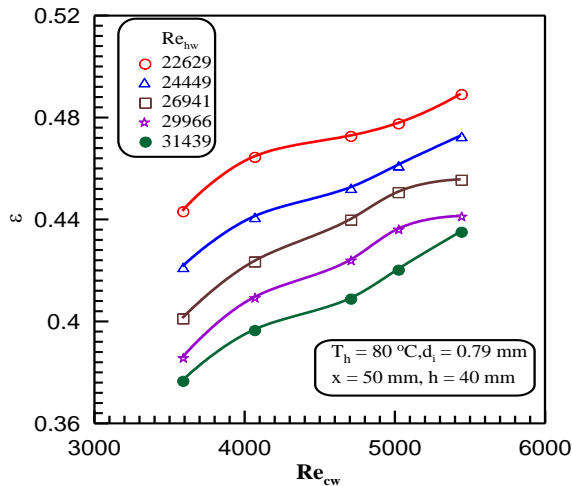

Fig. 10 Heat-exchanger effectiveness as a function of cold water Reynolds number for different hot-water flow rates

Figure 11 illustrates the mass transfer of the evaporative heat exchanger as a function of cold Reynolds number for different hot water flow rates. The figure indicates that, as the increase of cold water flow rate less vaporization occurs and the specific humidity of air decreases. This means that the mass transfer decreases with the increase of cold water flow rate. For the case of hot water Reynolds number 31439, the mass transfer of the evaporative heat exchanger is decreased from 0.187 to 0.171 g/sec as the Reynolds number of cold water is increased from 3585 to 5438. Therefore, there is 8.56 % decreasing in the mass transfer of the evaporative heat exchanger as the Reynolds number of cold water increasing by 51.67 %.

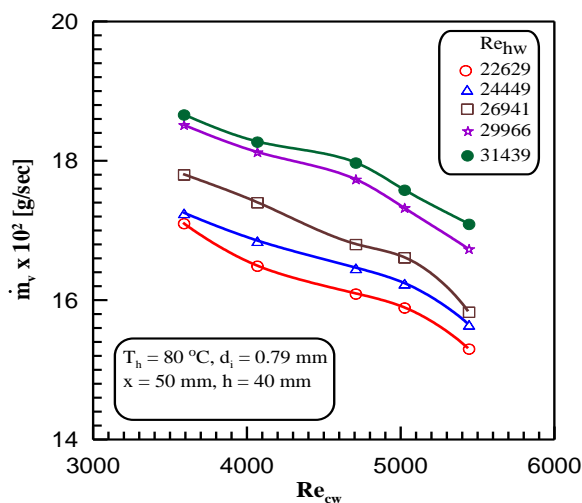

Fig. 11 Mass transfer as a function of cold water Reynolds number for different hot-water Reynolds number

3-3 Effect of hot water inlet temperature:

The effect of hot water inlet temperature on each of heat dissipated from the hot water coil, overall heat transfer coefficient, effectiveness and mass transfer of the experimental evaporative heat exchanger was studied and illustrated in Figs. 12 to 15. The studying was conducted at 50 °C, 60 °C, 70 °C and 80 °C. This effect was conducted for injection holes diameter of the cold water 0.79 mm, interval distance between the injections of the cold water was 50 mm, the height between the injection holes of the cold water and the first row of the hot water coil was 40 mm, cold water flow rate was 0.059 kg/sec and the air mass flow rate was 0.02 kg/sec. It is indicated from Fig. 12 that the heat dissipated from the hot water coil is increased with the increase of hot-water temperature. For the case of hot water Reynolds number 31439, the heat dissipated is increased from 5.48 kW to 9.28 kW as the hot-water inlet temperature was increased from 50 °C to 80 °C. Therefore, there is an increase of 34.31 % in the heat dissipated from the hot water as the hot-water temperature was increased by 60 %. The increasing of hot-water inlet temperature causes high hot-water temperature along the heat exchanger path, which results in high temperature difference between the hot water and cold water streams. Therefore the heat exchange is increased.

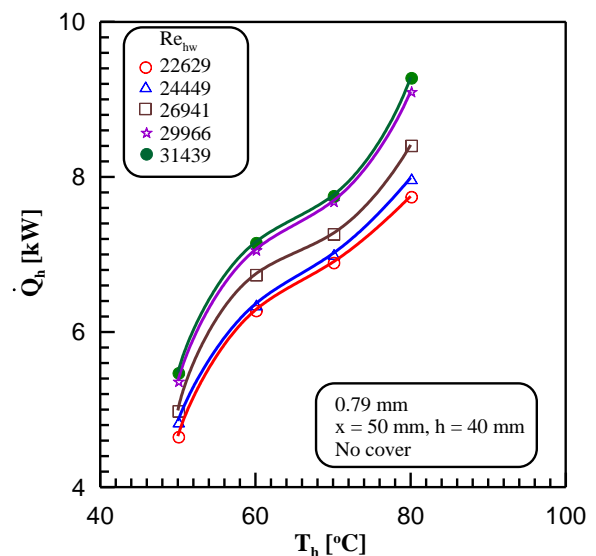

Fig. 12 Effect of hot water inlet temperature on heat dissipated for different hot water Reynolds number

Figure 13 indicates the effect of hot water inlet temperature on the overall heat transfer coefficient. It is seen that, the overall heat transfer coefficient of the hot water coil is decreased as the hot-water inlet temperature is increased. For hot water Reynolds number 31439 the overall heat transfer coefficient is decreased from 962 to 595 W/m².K as the hot-water temperature is increased from 50 °C to 80 °C. Therefore, there is 38.51 % decreasing in the overall

heat transfer coefficient from the hot water coil, as the hot-water temperature is increased by 60 %. The overall heat transfer coefficient from the hot water coil is a function of heat dissipated and logarithmic mean temperature difference.

The overall heat transfer coefficient of the hot water coil is in direct relation with the heat dissipated and is in reverse relation with the logarithmic mean temperature difference, see equation (4). Although the heat dissipated is increased when the hot water temperature is increased, but the overall heat transfer coefficient of the hot water coil is decreased as the hot water inlet temperature is increased. This indicates that the increasing of the logarithmic mean temperature difference is higher than the increasing of the heat dissipated as the hot water temperature is increased.

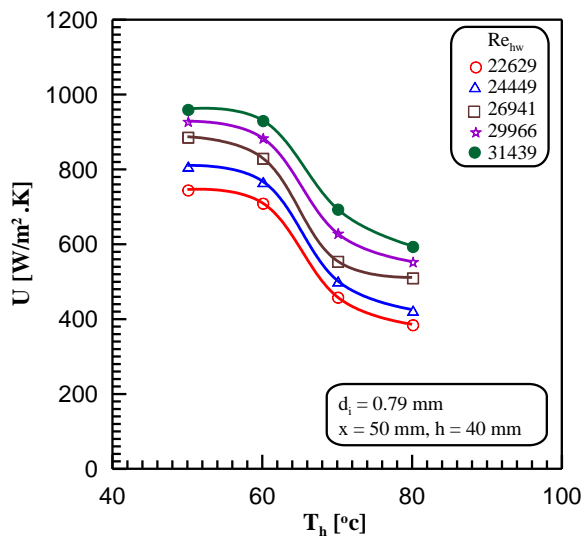

Fig. 13 Overall heat transfer coefficient as a function of hot water inlet temperature for different hot water Reynolds number

The effectiveness of the evaporative heat exchanger as a function of hot water inlet temperatures is illustrated in Fig. 14 for different hot-water flow rate.

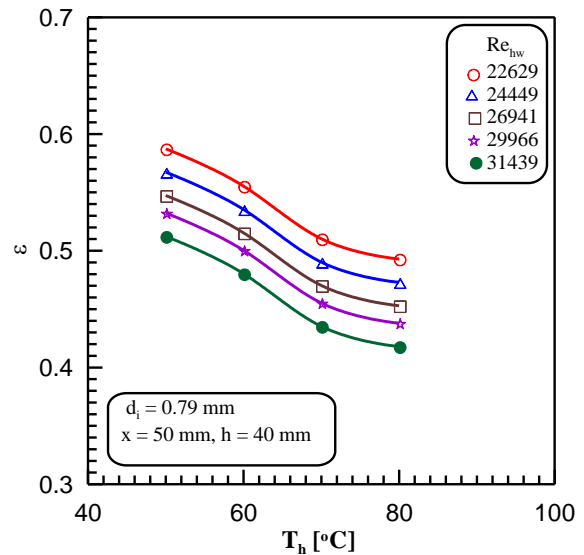

Fig. 14 Effect of hot water inlet temperature on Effectiveness of heat exchanger for different hot water Reynolds number

It can be seen that, the effectiveness of the evaporative heat exchanger is decreased as the hot-water inlet temperature is increased. For hot water Reynolds number 31439, the effectiveness is decreased from 0.51 to 0.41 as the hot-water temperature is increased from 50 °C to 80 °C. Therefore, there is 19.61 % decreasing in the effectiveness from the evaporative heat exchanger, as the hot-water temperature is increased by 60 %. This could be explained as, the increase of hot-water temperature leads to increase the difference between hot water inlet temperature and cold water inlet temperature, see Eq.(5). Consequently, the effectiveness of the experimental evaporative heat exchanger is decreased.

Figure 15 indicates the mass transfer as a function of hot water inlet temperatures for different hot-water flow rate. The mass transfer between cold water and air is increased slightly with the increase of hot-water inlet temperature between 50 °C and 60 °C after which the rate of increase mass transfer is increased. This is because the rate of heat transfer between hot water and cold water increases which in turn result in an increase of heat and mass transfer between cold water and air. For hot water Reynolds number 31439, the mass transfer is increased from 0.154 to 0.187 g/sec as the hot-water temperature is increased from 50 °C to 80 °C. Therefore, there is 21.43 % increasing in the mass transfer from the hot water as the hot-water temperature is increased by 60 %.

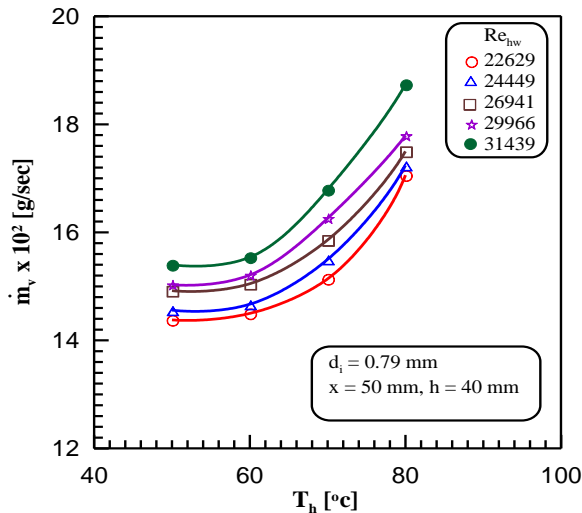

Fig. 15 Mass transfer as a function of hot water inlet temperature for different hot water Reynolds number

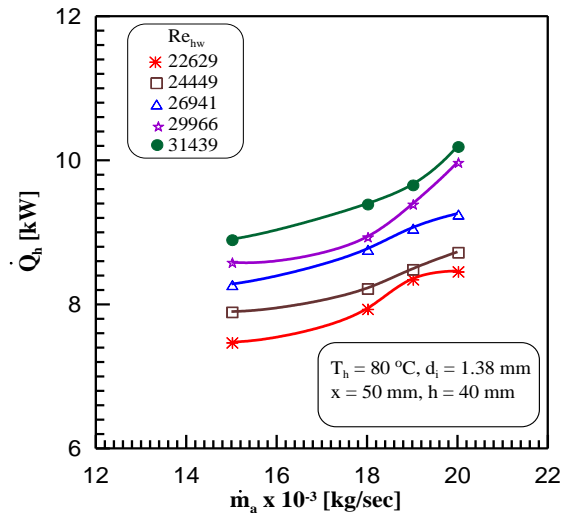

Fig. 16 Effect of air flow rate on heat dissipated for different hot water Reynolds number.

3-4 Effect of air flow rate:

The effect of air flow rate on each of heat dissipated from the hot water coil, overall heat transfer coefficient, the effectiveness and mass transfer of the experimental evaporative heat exchanger was studied. The studying was conducted at four values of air flow rate; they were 0.02, 0.019, 0.018 and 0.015 kg/sec. This effect was conducted for the case of bare hot water coil, 1.38 mm injection holes diameter, the interval distance between the injections of the cold water was 50 mm, the height between the injections of the cold water and the first row of the hot water coil was 40 mm, the hot water inlet temperature was 80 °C, hot water flow rate was 0.091 kg/sec and cold water flow rate was 0.079 kg/sec.

The effect of air flow rate is shown in Figs. 16 to 19. Figure 16 shows the heat dissipated from the hot water as a function of air mass flow rates for different hot-water flow rate. It is indicated that, the heat dissipated from the hot water coil increases with the increase of air flow rate.

For the case of hot water Reynolds number 31439, the heat dissipated is increased from 8.46 to 9.97 kW as the air flow rate is increased from 0.015 to 0.02 kg/sec. Therefore, there is 17.85 % increasing in the heat dissipated from the hot water as the air flow rate is increased by 33.33 %. The increasing of air flow rate decreases the cold-water temperature along the heat exchanger path, which results in high temperature difference between the two streams (cold and hot water), so the heat exchange is increased. Also the increasing of air flow rate decreases the air temperature along the heat exchanger path, which results high temperature difference between the two streams (air and hot water), so the heat exchange is increased.

Figure 17 shows the overall heat transfer coefficient from the hot water coil as a function of air mass flow rates for different hot-water flow rate. It is seen that, the overall heat transfer coefficient from the hot water coil is increased as the air mass flow rate is increased. For hot water Reynolds number 31439, the overall heat transfer coefficient is increased from 1008 to 1171 W/m².K as the air flow rate is increased from 0.015 to 0.02 kg/sec. Therefore, there is an increase of 16.17 % in the overall heat transfer coefficient from the hot water coil, as the air flow rate is increased by 33.33 %. This could be explained as, the increasing of air flow rate decreases the cold-water temperature along the heat exchanger path, which results in high temperature difference between the two streams (cold and hot water) so the heat exchange is increased.

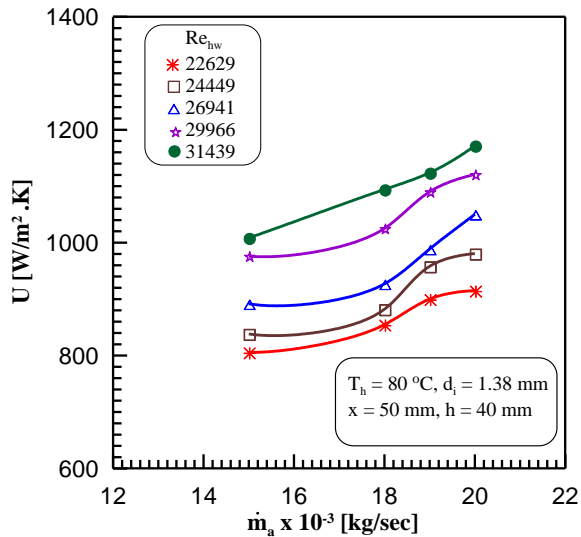

Fig. 17 Overall heat transfer coefficient as a function of air mass flow rates for different hot water Reynolds number

Also, the increase of air flow rate decreases the temperature difference of air along the heat exchanger path, which results in high temperature difference between the two streams (hot water and air), so the heat exchange is increased. Thus the overall heat transfer coefficient is increased as the heat exchange is increased.

Figure 18 illustrates the effectiveness of the evaporative heat exchanger as a function of air mass flow rates for different hot-water flow rate. The figure indicates that, the effectiveness of the evaporative heat exchanger is increased as the air mass flow rate is increased. For the case of hot water Reynolds number 31439, the effectiveness is increased from 0.47 to 0.52 as the air flow rates is increased from 0.015 to 0.02 kg/sec. Therefore, there is an increase of 10.64 % in the effectiveness from the experimental evaporative heat exchanger, as the air flow rates is increased by 33.33 % at this condition. This because the increase of air flow rate decreases the cold-water temperature along the heat exchanger path, which results high temperature difference between the two streams (cold and hot water), so the heat exchange is increased. Also, the increase of air flow rate tend to decrease the air temperature difference along the heat exchanger path, which results in high temperature difference between the two streams (hot water and air), so the heat exchange is increased. Thus the effectiveness is increased as the heat exchange is increased.

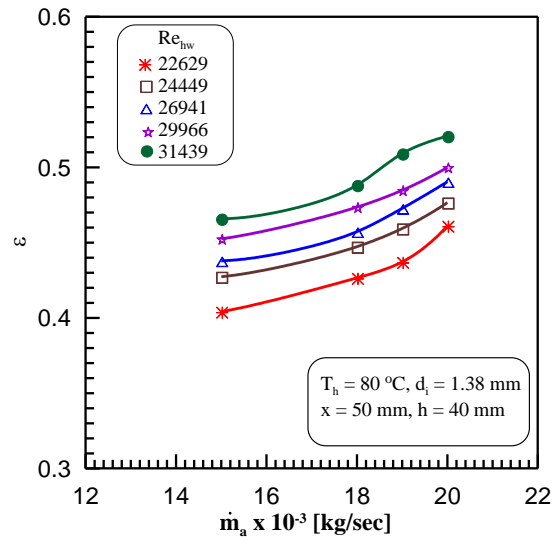

Fig. 18 Effectiveness as a function of air mass flow rates for different hot water Reynolds number

Figure 19 illustrates the effect of air flow rates on mass transfer for different hot-water flow rate for different. The figure indicates that, as the increase of air flow rate more vaporization occurs and the specific humidity of air increases. This means that the mass transfer increases with the increase of air flow rate. For the case of hot water Reynolds number 31439, the mass transfer of the evaporative heat exchanger is increased from 0.121 to 0.179 g/sec as the air flow rate is increased from 0.015 to 0.02 kg/sec. Therefore, there is 47.97 % increasing in the mass transfer as the air flow rate is increased by 33.33 %.

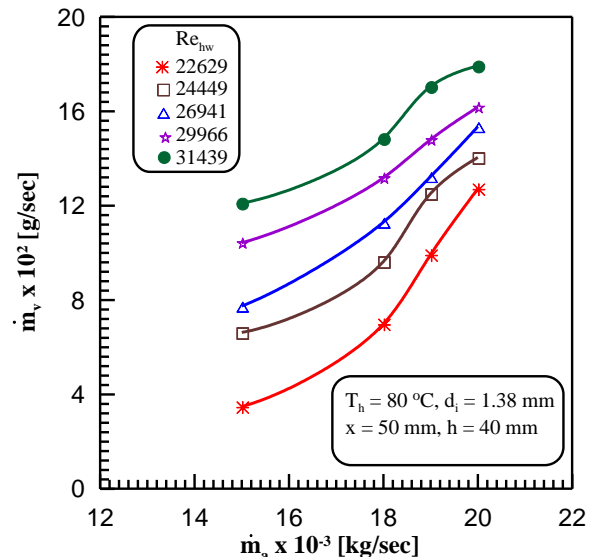

Fig. 19 Effect of air mass flow rates on mass transfer for different hot water Reynolds number

3-5 Effect of the distance between injection holes:

The distance between injection holes affects each of heat dissipated from the hot water, overall heat transfer coefficient, the effectiveness and mass transfer of the experimental evaporative heat exchanger. This effect was studied at two cases. First case was conducted at 50 mm difference (16 outlets for cold water), second one was conducted at 100 mm distance (8 outlets for cold water). This effect was conducted under the following circumstances; the hot water coil was a bare tube, the injection diameter of the cold water was 0.79 mm, the height between the injections of the cold water and the first row of the hot water coil was 40 mm, the hot water inlet temperature was 80 °C, cold-water flow rate was 0.059 kg/sec and the air mass flow rate was 0.02 kg/sec. The effect of the distance between injection holes is shown in Figs. 20 to 23. Figure 20 shows the heat dissipated from the hot water as a function of hot-water flow rate for different distance between injection holes. It is indicated that, the heat dissipated from the hot water coil is decreased as the distance between injection holes is increased.

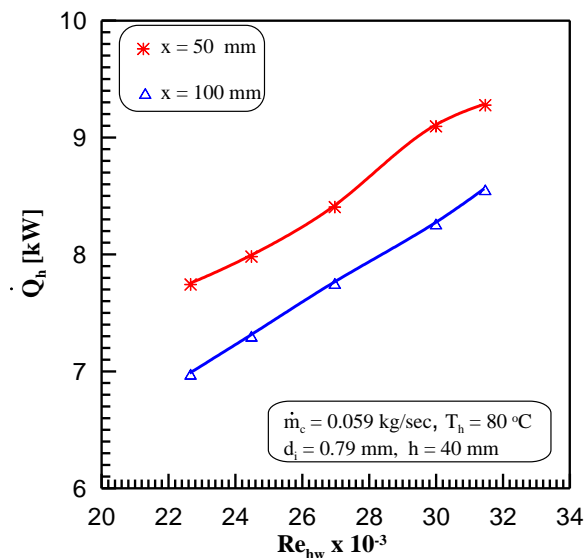

Fig. 20 Heat dissipated from hot water as a function of hot water Reynolds number for different distance between injections.

For the case of hot water Reynolds number 31439, the heat dissipated is decreased from 9.28 to 8.56 kW as the distance between injection holes is increased from 50 to 100 mm. Therefore, there is 7.76 % decreasing in the heat dissipated from the hot water as the distance between injection holes is increased by 50 %. This could be explained as, for small distance between injection holes, more cold water outlets (16 outlets) which imply low outlet velocity for cold water as the cold water flow rate was constant. This causes more uniform cold water distribution over the hot water coil which results in

high heat exchange between the two streams as shown in the figure.

Figure 21 indicates the overall heat transfer coefficient of the hot water coil as a function of hot-water flow rate for different distance between injections. The overall heat transfer coefficient of the hot water coil is decreased as the distance between injection holes is increased. For the case of hot water Reynolds number equal to 31439, the overall heat transfer coefficient is decreased from 909 to 790 W/m².K as the distance between injections is increased from 50 to 100 mm. Therefore, there is 13.1 % decreasing in the overall heat transfer coefficient from the hot water as the distance between injections is increased by 50%. The decreasing of the distance between injection holes causes more uniform cold water distribution over the hot water coil which results in high heat transfer between the two streams. High heat transfer means high overall heat transfer coefficient for the hot water coil.

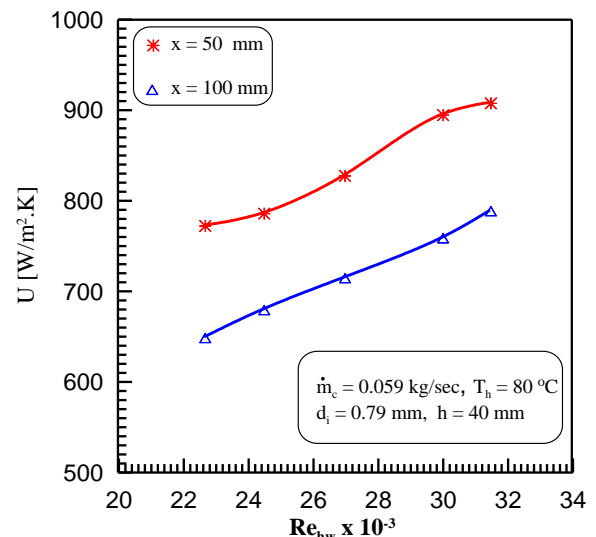

Fig. 21 Overall heat transfer coefficient as a function of hot water Reynolds number for different distance between injections

Figure 22 illustrates the effectiveness of the evaporative heat exchanger as a function of hot-water flow rate for different distance between injection holes. The effectiveness of the evaporative heat exchanger is decreased as the distance between injection holes is increased. For the case of hot water Reynolds number 31439, the effectiveness is decreased from 0.40 to 0.36 as the distance between injection holes is increased from 50 mm to 100 mm. Therefore, there is 10% decreasing in the effectiveness of the evaporative heat exchanger as the distance between injections is increased by 50 %. The decreasing of distance between injections causes more uniform cold water distribution over the hot

water coil which results in high heat exchange between the two streams. High heat exchange means high effectiveness for the experimental evaporative heat exchanger as the distance between injections is decreased.

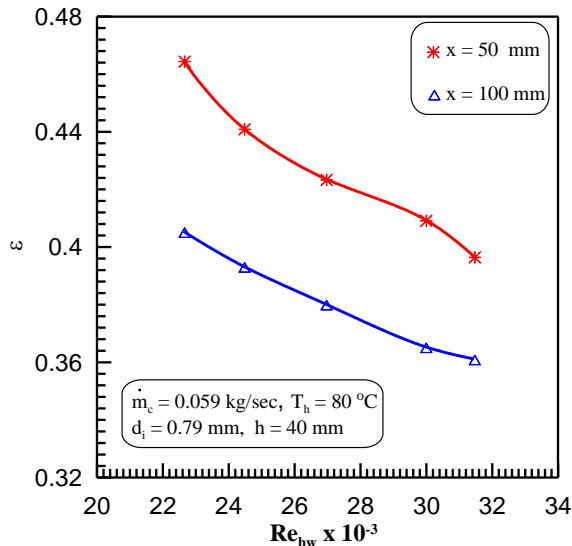

Fig. 22 Heat-exchanger effectiveness as a function of hot water Reynolds number for different distance between injections

Figure 23 indicates the mass transfer as a function of hot-water flow rate for different distance between injection holes. The mass transfer is decreased as the distance between injection holes is increased.

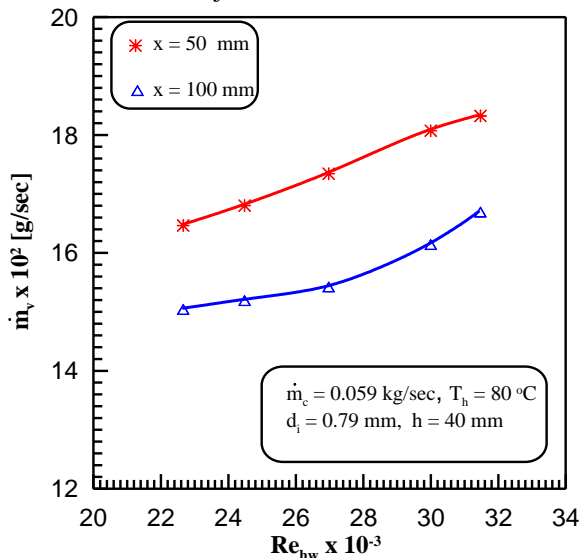

Fig. 23 Mass transfer as a function of hot water Reynolds number for different distance between injections

For the case of hot water Reynolds number 31439, the mass transfer is decreased from 0.183 to 0.167 g/sec as the distance between injection holes is increased from 50 to 100 mm. Therefore, there is 8.7 % decreasing in the mass transfer as the distance between injection holes is increased by 50 %. This could be explained as, for small distance between injection holes, a more cold water outlets (16 outlets) which imply low outlet velocity for cold water as the cold water flow rate was constant. This causes more uniform cold water distribution over the hot water coil which results in low mass transfer between the two streams as shown in the figure.

3-6 Effect of injection holes diameter:

The effect of injection holes diameter on each of heat dissipated from the hot water coil, overall heat transfer coefficient, the effectiveness and mass transfer of the experimental evaporative heat exchanger was studied at three diameters, mainly 0.79 mm, 1.39 mm and 1.78 mm. This effect was conducted under the following circumstances; the interval distance between the injection holes of the cold water was 50 mm, the height between the injections of the cold water and the first row of the hot water coil was 40 mm, the inlet hot water temperature was 80 °C, cold-water flow rate 0.059 kg/sec and the air mass flow rate was 0.02 kg/sec. The effect of injection diameter is shown in figures 24 to 27. Figure 24 shows the heat dissipated from the hot water as a function of hot-water flow rate for different injection diameters. It is indicated that, the heat dissipated from the hot water coil is increased as the injection diameter is increased. For the case of hot water Reynolds number 31439, the heat dissipated is increased from 9.28 to 10.46 kW as the injection holes diameter is increased from 0.79 to 1.78 mm. Therefore, there is 12.72 % increasing in the heat dissipated from the hot water when the injection diameter is increased from 0.79 to 1.78 mm. This may be explained as the decreasing of the injection diameter increases the outlet velocity of cold water. High cold water velocity facing the first row of the hot water coil tends to reduce the cold water film around the surface of the hot water coil. Also, High cold water velocity facing the first row of the hot water coil causes non-uniform of cold water distribution over the rest of the hot water coil surface, as the hot water coil is in a vertical plane (10 rows in-line arrangement).

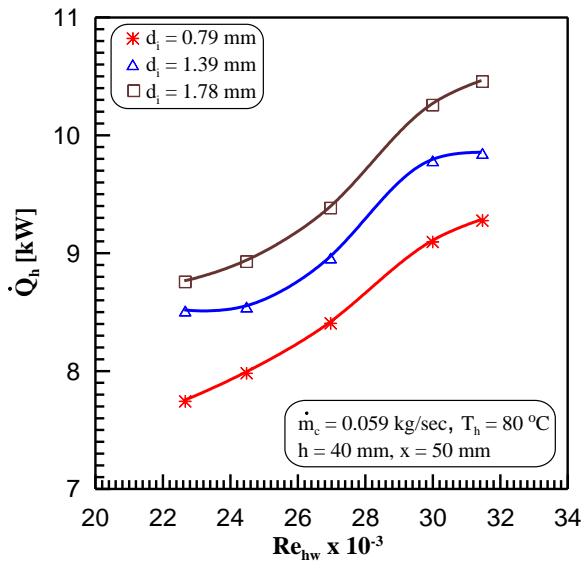

Fig. 24 Heat dissipated from the hot water as a function of hot- water flow rate for different of injection diameter.

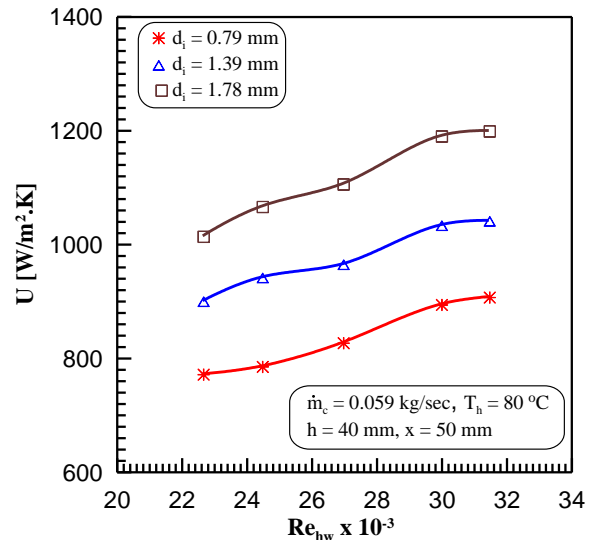

Fig. 25 Overall heat transfer coefficient as a function of hot water Reynolds number for different of injection diameter.

The overall heat transfer coefficient of the hot water as a function of hot-water flow rate for different injection diameters is shown in Fig. 25.

It could be seen that, the overall heat transfer coefficient of the hot water coil is increased as the injection holes diameter is increased. For the case of hot water Reynolds number equal to 31439, the overall heat transfer coefficient is increased from 909 to 1201 $W/m^2.K$ with percentage increase of 32.12 when the injection holes diameter is increased from 0.79 mm to 1.78 mm. This may be explained as, the increasing of injection diameter increases the heat transfer so the overall heat transfer coefficient is increased and vice versa.

It could be seen that, the overall heat transfer coefficient of the hot water coil is increased as the injection holes diameter is increased. For the case of hot water Reynolds number equal to 31439, the overall heat transfer coefficient is increased from 909 to 1201 $W/m^2.K$ with percentage increase of 32.12 when the injection holes diameter is increased from 0.79 mm to 1.78 mm. This may be explained as, the increasing of injection diameter increases the heat transfer so the overall heat transfer coefficient is increased and vice versa.

Figure 26 illustrates the effectiveness of the evaporative heat exchanger as a function of hot-water flow rate for the three chosen cases of injection holes diameter.

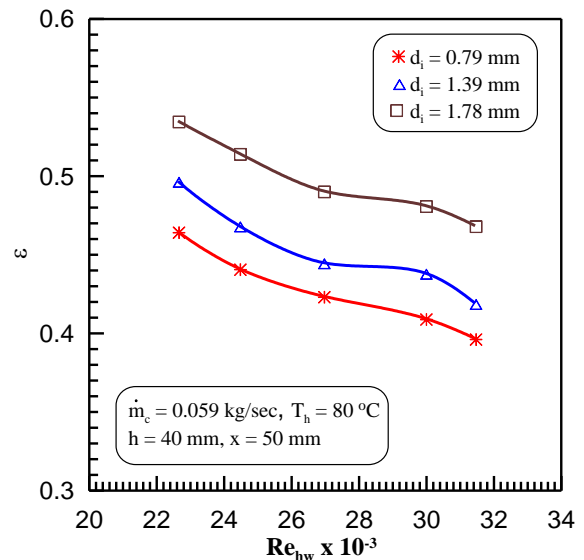

Fig. 26 Heat-exchanger effectiveness as a function of hot water Reynolds number for different injection diameter

The figure shows that, the effectiveness of the evaporative heat exchanger is increased as the injection diameter is increased. For the same case of hot water Reynolds number "31439", the effectiveness is increased from 0.40 to 0.47 as the injection diameter is increased from 0.79 mm to 1.78 mm. Therefore, there is 17.5 % increasing in the effectiveness of the experimental evaporative heat exchanger for this case. The increasing of injection diameter increases the heat transfer so the overall heat transfer coefficient is increased and vice versa.

The figure shows that, the effectiveness of the evaporative heat exchanger is increased as the injection diameter is increased. For the same case of hot water Reynolds number "31439", the effectiveness is increased from 0.40 to 0.47 as the injection diameter is increased from 0.79 mm to 1.78 mm. Therefore, there is 17.5 % increasing in the effectiveness of the experimental evaporative heat exchanger for this case. The increasing of injection diameter increases the heat transfer so the overall heat transfer coefficient is increased and vice versa.

Figure 27 indicates the mass transfer of the hot water as a function of hot-water flow rate for different injection diameters. It could be seen that, the mass transfer as a function of the hot water flow rate is increased as the injection holes diameter is increased.

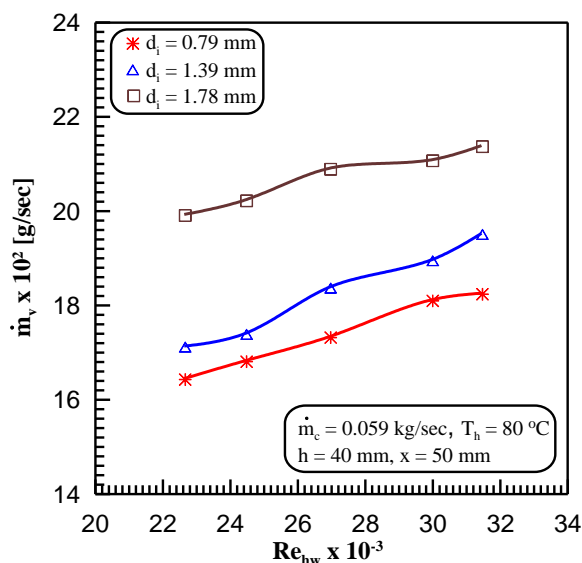

Fig. 27 Mass transfer as a function of hot water Reynolds number for different injection diameter

For the case of hot water Reynolds number equal to 31439, the mass transfer is increased from 0.183 to 0.214 g/sec with percentage increase of 16.94 when the injection holes diameter is increased from 0.79 mm to 1.78 mm. This may be explained as, the increasing of injection diameter increases the heat transfer so the mass transfer is increased and vice versa.

Conclusions:

The experimental investigation of some parameters those affect on heat and mass transfer in evaporative heat exchanger led to the following conclusions:

- 1- The heat dissipated from hot water coil increases with the increase of each of hot water flow rate, cold water flow rate, hot water inlet temperature, air mass flow rate and injection holes diameter while it is decreased with the increase of horizontal distance between injection holes.
- 2- The overall heat transfer of the hot water coil increases with the increase of hot water flow rate, cold water flow rate, air flow rate and injection holes diameter while it is decreased with the increase of hot water inlet temperature and the horizontal distance between injection holes.
- 3- The effectiveness of the tested evaporative heat exchanger increases with the increase of cold water flow rate, air flow rate and injection holes diameter while it is decreased with the increase of hot water flow rate and its inlet temperature and the horizontal distance between injection holes.
- 4- The mass transfer increases with the increase of hot water flow rate, hot water inlet temperature, air mass flow rate and injection holes diameter while it is decreased with the increase of cold water flow rate and horizontal distance between injection holes.

Nomenclature:

- A : Area, m²
 C : Fluid velocity, m/s
 C_p: Specific heat of water, J/(kg. K)
 d : Tube inlet diameter, mm.
 h: Height between the injection holes of the cold water and the first row of the hot water coil, mm
 L : Active length of hot water coil, m
 Re : Reynolds number.
 T : Temperature, °C
 U : Overall heat transfer coefficient, W/m².K
 x : Distance between the injection holes, mm
 Q̇ : Heat dissipated rate, kW
 ṁ : Mass flow rate, kg/s

Greek Symbol:

- ω : Specific humidity, g/kg_{da}
 Θ : Logarithmic temperature difference
 μ : Dynamic viscosity, kg/m.s
 ε : Effectiveness of evaporative heat exchanger
 π : Approximate ratio, $\pi = 22/7$
 ρ : Water density, kg/ m³

Subscript:

- | | |
|-----------|------------|
| 1 : Inlet | 2: Outlet |
| a : Air | c : Cold |
| h : Hot | i : Inlet |
| m: Mean | o : Outlet |
| v : vapor | w : Water |

References:

- 1- Ralph L.Webb And Alejandro Villacres, "Performance Simulation of Evaporative Heat exchangers [Cooling Towers, Fluid coolers, and Condensers]" heat transfer engineering , Vol. 6 , No. 2, pp. 31-38, 1985.
- 2- R. S. Rana, V. Charan and H. K. Varmat, "Heat and mass transfer from a horizontal tube of an evaporative heat dissipator" hr. J. Heo~ Mass Transfer. Vol. 29, No. 4, pp. 555-562, 1986.
- 3- Christine Backman, Alea German, Bill Dakin, and Elizabeth Wetzal, "Evaporative Condenser Lab and Field Test Results" ACEEE Summer Study on Energy Efficiency in Buildings , pp.37-50, 2012.
- 4- A. V. Bykov, V. A. Gogolin and N. V. Tovaras, "Investigation of heat, mass transfer and fluid flow characteristics in evaporative condensers" International Journal of Refrigeration Vol. 7 No. 6, pp. 342-347, Nov. 1984.
- 5- Wojciech Zalewski, "Mathematical model of heat and mass transfer processes in evaporative condensers" Int. J. Refrig. Vol.16 No 1, pp. 23-30, 1993.
- 6- Nenad Radojković1, Goran Vučković1, Mića Vukić1, Gradimir Ilić1 and Žarko Stevanović2, "Experimental investigation of tube bundle Wetting influence on heat transfer intensity in evaporative heat exchanger" FACTA Universitatis, Series: Mechanical Engineering Vol. 1, No 10, pp. 1385 – 1392, 2003.
- 7- Ala Hasan and Kai Siren, "Performance investigation of plain and finned tube evaporatively cooled heat exchangers" Applied Thermal Engineering Vol. 23, pp. 325–340, 2003.
- 8- M. Hosoz and A. Kilicarslan, "Performance evaluations of refrigeration systems with air-cooled, water-cooled and evaporative condensers" Int. J. Energy Res. Vol. 28, pp. 683-696, 2004.
- 9- Rajneesha and Raj Kumarb, "Experimental Study of Falling Film Heat Transfer on a Horizontal Tube of an Evaporative Tubular Heat Dissipator" Int. J. of Current Engineering and Technology, Vol. 3, pp. 940-949, 2013.
- 10- Rajneesha and Raj Kumarb, "Performance Analysis of a Row of Horizontal Tubes of an Evaporative Tubular Heat Exchanger" Int. J. of Thermal Technologies, Vol. 3, pp. 92-98, 2013.
- 11- Rajneesha and Raj Kumarb, "Experimental Analysis of a Tubular type of Evaporative Heat Exchanger" Proc. of the Intl. Conf. on Advances in Civil, Structural and Mechanical Engineering ACSM pp., 49-53, 2015.
- 12- Ivoni Carlos Acunha Junior, Felipe Marquardt Walther, Paulo Smith Schneider and Paulo Otto Beyer, "Experimental Analysis of an Evaporative Condenser" 13th Brazilian Congress of Thermal Sciences and Engineering December Uberlandia, MG, Brazil, 05-10, 2010.
- 13- Gaosheng Wei, Jingqiu Ren and Wenpeng Hong, "Scheme Design and Analysis of Variable Condition of Evaporative Condenser for Steam Condensing of Steam Feeding Water Pump for 1000MW Air-cooled Unit" Energy Procedia 17, pp.1177–1184. 2012.
- 14- Hisham M. Ettouney, Hisham T. El-Dessouky, Walid Bouhamra, And Bader Al-Azmi, "Performance of Evaporative Condensers" Heat Transfer Engineering, 22, pp. 41–55, 2001.
- 15- Sachin Duhan and Raj Kumar, "Evaporative Effectiveness & Mass Transfer Coefficient of a U-Shape Brass Tube of an Evaporative Heat Exchanger." International Journal for Research in Applied Science and Engineering Technology (IJRASET), Vol. 2 Issue VIII, Pp. 122-127, August 2014.
- 16- Vikas Chander and Kitab Singh, "Experimental study of dry out heat flux and mass transfer coefficient effect on a Single Horizontal Copper tube of an Evaporative Tubular Heat Dissipator" International Journal of Latest Trends in Engineering and Technology (IJLTET), Vol. 3 Issue 4, pp. 327-337, March 2014.