

On-line Fault Detection of Transmission Line Using Artificial Neural Network

التعرف اللحظي على الأعطال الخاصة بخطوط نقل القوى الكهربائية باستخدام الشبكات العصبية الصناعية

Samah M. El Safty Hamdy A. Ashour Hesien El Dessouki and Mohamed El Sawaf
Faculty of Engineering, Arab Academy for Science and Technology, Alexandria, Egypt

المستخلص -- عند حدوث أحد الأخطاء في شبكات النقل الكهربائي فإن أشكال الموجات الخاصة بكل من الجهد والتيار الكهربائي تتغير أثناء هذه الأخطاء. هذا التغير يأخذ شكلاً معيناً تبعاً لنوع كل خطأ. لهذا فإنه يمكن استخدام الشبكات العصبية للتعرف على نوع الخطأ نظراً لقدرةها على التمييز بين الأشكال المختلفة. وفي هذا البحث يتم أولاً تسجيل موجات الجهد والتيار المختلفة في حالات التشغيل الطبيعي وكذلك في حالة الأعطال وذلك حتى يسهل على الشبكات العصبية التعرف عليها في أسرع وقت ممكن. وقد تم استخدام برنامج محاكاة EMTP لتمثيل المنظومة. كما تم أيضاً استخدام منظومة محاكاة كهربائية معملية مكونة من مصدر للجهود ثلاثي الأوجه وحط نقل كهربائي ثلاثي الأوجه مع بناء مجموعة من الدوائر الكهربائية للربط بين الجهود والتيارات المقاسة وتغذيتها إلى جهاز حاسوب شخصي PC والذي تم استخدامه لتفعيل برنامج الشبكات الصناعية والتعرف على نوع الخطأ وكذلك الفصل اللحظي للكهرباء عن المنظومة وذلك باستخدام برنامج Matlab. وقد أثبت النظام المقترح فاعلية وسهولة في التعرف على الأخطاء ولذلك فمن الممكن تقديم هذه الفكرة للتطبيق في أنظمة الحماية العملية.

Abstract-- As the voltage and current waveforms are deformed due to transient during faults, their pattern changes according to the type of fault. The Artificial Neural Network (ANN) can then be used for fault detection due to its distinguished behavior in pattern recognition. In order to minimize the structure and timing of the ANN, preprocessing of the voltage and current waveforms was done. The data delivered from a simulated power system using PSCAD (EMTP with cad system) was used for training and testing the ANN. An experimental setup, consists of a 3 phase power supply module and transmission line module, is utilized. A set of signal conditioning circuits is designed and implemented in order to transfer data to a PC which is used as an on-line relay for fault detection. This is done via a data acquisition card (CIO-DAS1602/12). The Matlab program captures and processes real data for training the ANN. Applying different types of faults for testing the system, right tripping action was taken and the type of fault was correctly identified. The suggested artificial neural network algorithm has been found simple and effective hence could be implemented in practical application.

1. Introduction

The fundamental objective of system protection is to provide isolation of the problem area, keeping the rest of the system to continue in service. The protective relays act after the occurring of an abnormal or intolerable condition, in order to minimize the duration of the trouble and limit the damage and outage time. During the fault, transients arise in both voltage and current waveforms. Symmetrical components technique has been used to analyze such waveforms for fault detection [1]. The presence of monitoring subsystem makes it possible to process data directly received from the power system during fault

conditions; hence the measured signals could be used for relaying conditions [2]. As the digital technology is being ever increasingly adopted in protection, shorter decision time has been achieved [3]. Various applications of the artificial neural network (ANN) were used to improve recognition of faults on transmission lines [4]. Many researchers used the ANN for fault detection, as it can handle most situations which cannot be defined sufficiently for finding a deterministic solution [5-7]. As a result, ANN has emerged as a powerful pattern recognition technique wherever computers interact with real world [8]. In this paper, simulation of the system under study is carried out using PSCAD/EMTDC [9]. The voltage and current

waveforms obtained from simulation at relay location are processed and then used for training the ANN. The suggested ANN is implemented on an experimental transmission line module and the practical waveforms are compared with the corresponding simulated waveforms.

2. System Simulation and Data Processing

The PSCAD/EMTDC is a standard industrial simulation tool for studying the transient behavior of electrical networks. Its graphical user interface enables all aspects of the simulation to be conducted within a single integrated environment including circuit assembly, run time control and analysis of results. In order to train the ANN, set of data corresponding to normal and fault conditions should be available. The suggested power system comprises of a generator connected to a transmission line through a transformer. The PSCAD/EMTDC built in library has been utilized to simulate each part of such system. The waveforms of voltages and currents during normal conditions at the relay location at the sending end of the transmission line are recorded. Also, waveforms corresponding to different fault types; including line to ground fault, line to line fault, line to line to ground fault and three phase faults, are obtained. When analyzing the acquired data, it was significant that during fault conditions the voltage of the faulted line tends to decrease to zero while the current tends to increase. In order to magnify the difference between different types of faults to be able to distinguish between different fault types processing of data, (V-I), is suggested as shown in Figure 1 a, b and c.

Taking the average difference of the (V-I) enhances and magnifies the variation between the healthy and faulted waveform and can be given as [7]:

$$y = (x_{i+1} - x_i) + (x_{i+2} - x_{i+3}) \quad (1)$$

Where x_i is the i^{th} value of such difference signal (V-I). Define the Sum of Averaged Differences (SADI) as:-

$$F_i = \sum_{i=-5}^{i=+5} abs(y_i) \quad (2)$$

The waveforms will be clearly distinguished during fault conditions as shown in Figure2 in per-unit

scale as the maximum value of (V-I) signal is taken as a base value.

3. Artificial Neural Network Architecture

The simulated power system data obtained after being processed is used for training the proposed ANN. Multilayer feed-forward networks were chosen to process the prepared input data. A feed-forward ANN contains an input layer, an output layer and possibly many hidden layers. Each layer can have one or many neurons (processing nodes). The node receives its input through a set of weighted links.

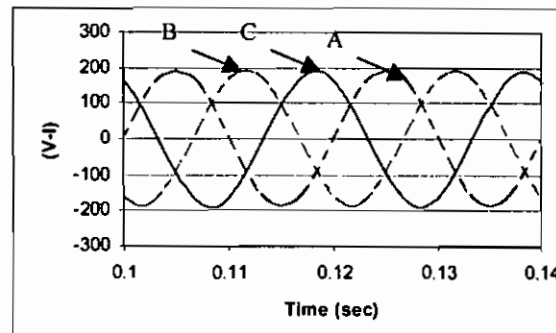

a)

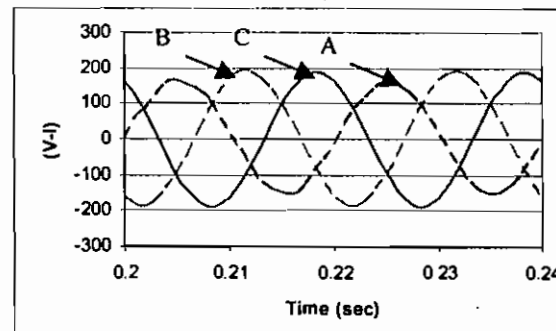

b)

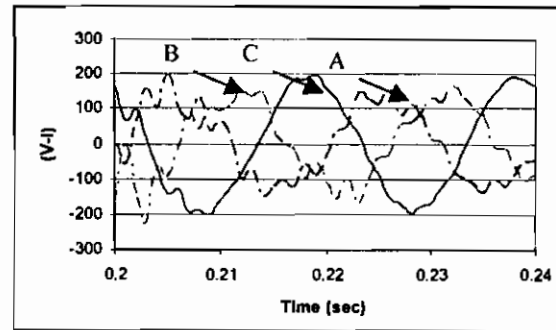

c)

Figure1. Simulated (V-I) waveforms for a) Normal case b) A to G fault c) A to B to G fault at 0.2 sec

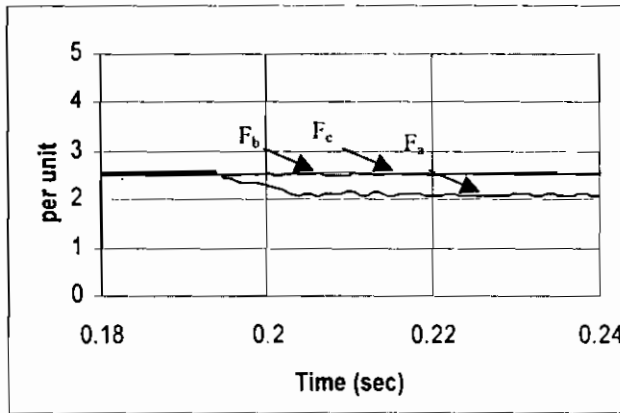

Figure2. The SADI for A to G fault at 0.2 sec

The output node is determined by an output function that responds to its activation. Frequently the so called sigmoid output function is used, as given by:-

$$f(x) = \frac{1}{1 + e^{-x}} \quad (3)$$

The ANN is trained using back propagation learning algorithm which exploits gradient information of the error function as:-

$$E_m = \frac{1}{2} \sum_z (t_{mz} - o_{mz})^2 \quad (4)$$

Where t_{mz} is the desired output of pattern and O_{mz} is actual net output. In the proposed ANN, 20 samples per cycle were taken from the processed data in the form of three SADI signals (F_i). The inputs are in the form of moving window for each four samples. A total of 38 signals are taken as input and the ANN is trained using all possible fault conditions until the error function reached 10^{-5} . The ANN has four outputs corresponding to the three phases (A, B & C) and the ground (G) as depicted in the ANN architecture shown in Figure3. The proposed ANN has been found able to perform fast and correctly for fault type recognition and may be then extended to include other conditions such as fault location. Also the effect of system parameter variations such as transmission line capacitance, load level and fault resistance may be included if needed in the training algorithm of the ANN technique. This is the powerful of such ANN over the other protection

schemes such as over current or symmetrical components analysis.

4. Hardware Implementation

The proposed ANN for fault type detection is tested on an experimental transmission line module of 360 km length fed from a three phase supply unit via a three phase transformer. The scale factor used for the system is 1 kV=1V, 1kA=1A and 1MVA=1VA. A photograph of the implemented experimental setup is shown in Figure4.

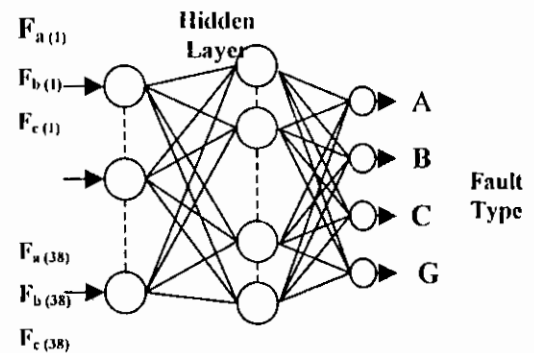

Figure 3. The proposed ANN Architecture

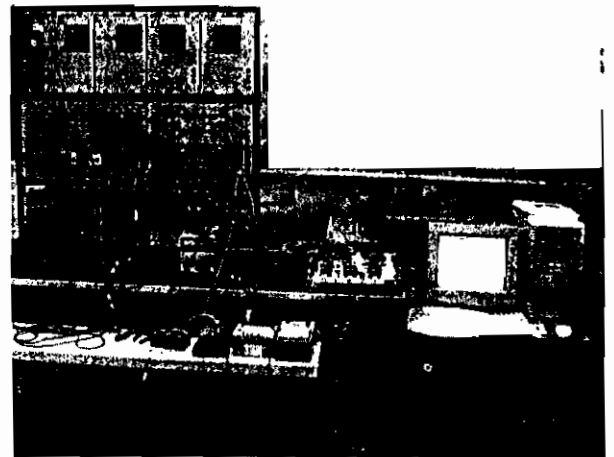

Figure4. A photograph of the complete experimental setup

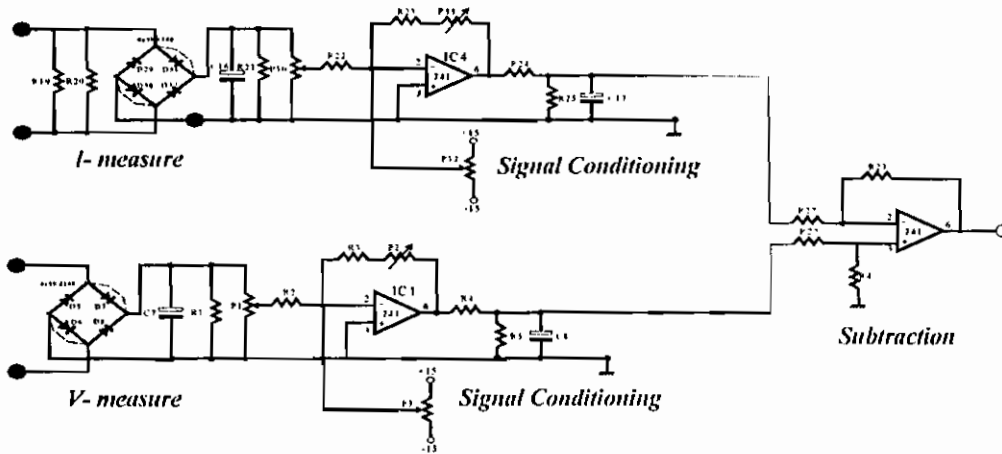

Figure5. Measurement, signal conditioning and subtraction electronic circuit (for one phase)

The new technology in the computer field has introduced computer cards for interfacing between computers and external processes. Data Acquisition Card (CIO-DAS1602/12) board is utilized. The MATLAB 6.5 data acquisition toolbox is used, providing a complete set of tools for communicating and operating a variety of data acquisition hardware. The PC can be configured to read, analyze and send data through such a toolbox. The phase voltages and currents must be converted to a form that the DAQ board can accept. A design of signal conditioning card has been built and tested using Electronic Workbench program. The proposed card consists of a power supply, voltage circuit with maximum input of 250 V and current circuit with maximum input of 5 A. The expected output voltage and current levels are ± 10 V. The subtracting circuit (V-I) reduced the acquired signals to only three instead of six, enabling the PC to get more samples for every cycle ($T_s=0.0025$ sec). Components of the electronic circuit for only one phase are shown in figure5. In this circuit the voltage signal received from a voltage transformer (not shown) is rectified through an H-bridge and a capacitor is used in order to get the maximum peak value, then a signal conditioning circuit is utilized for voltage adjustment suitable for the PC acquisition card. Same technique is introduced in the current measuring circuit except that a shunt resistance is used in the input signal for conversion to the corresponding voltage level signal. The outputs of V and I signal conditioning circuits are subtracted to get the require signal corresponding to

the (V-I) value for each phase to be fed to the PC card. Filters may be added to the circuit for noise rejection or overcoming any possible anti-aliasing problems, however such filters will introduce unwanted time delay in the actual acquired data.

5. Testing and Discussion

The complete set is practically connected and examples of the running experimental results obtained are shown in figures 6 and 8. The (V-I) waveforms during normal and faulted conditions are recorded using the PC as shown in Figure6 a, b and c. For detection of fault type using ANN a Matlab m-file is written based on the flow chart shown in Figure7. Applying different fault types on the transmission line, the program on the PC was able to detect the presence of the fault and trip the line, then using the recorded data to identify the type of fault. Waveforms of the SADI of the experimental setup for A to G fault could be seen in Figure8. It can be seen that the experimental results in figures 6 and 8 match with the corresponding simulated results shown in figures 1 and 2. It should be noted that the utilization of the PC data acquisition card and the Matlab program has introduced a powerful and interactive media together with simplest and effective implementation of the sophisticated ANN algorithm based on ANN and real time tool boxes supported by the Matlab program. The proposed technique may be also implemented using a stand-alone micro-controller or digital signal processor (DSP) based system with

expected faster response but with more sophisticated software programming and hardware connections.

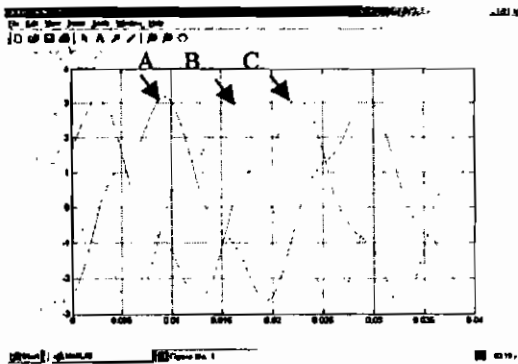

a)

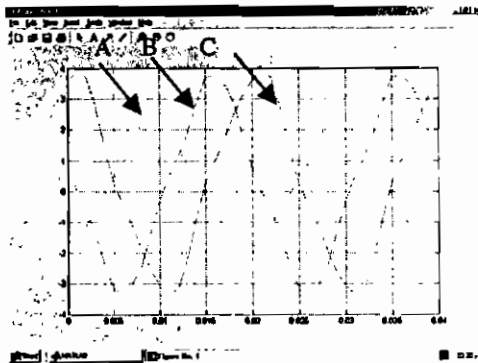

b)

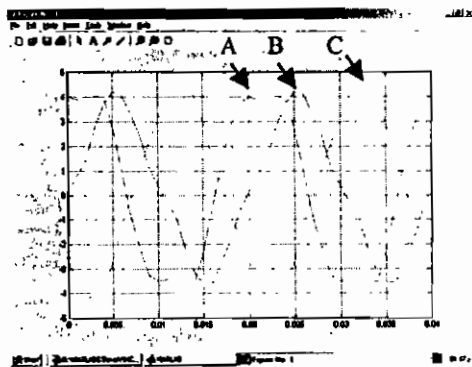

c)

Figure6. (V-I) waveforms from the experimental setup a) normal case b) A to G fault c) A to B to G fault

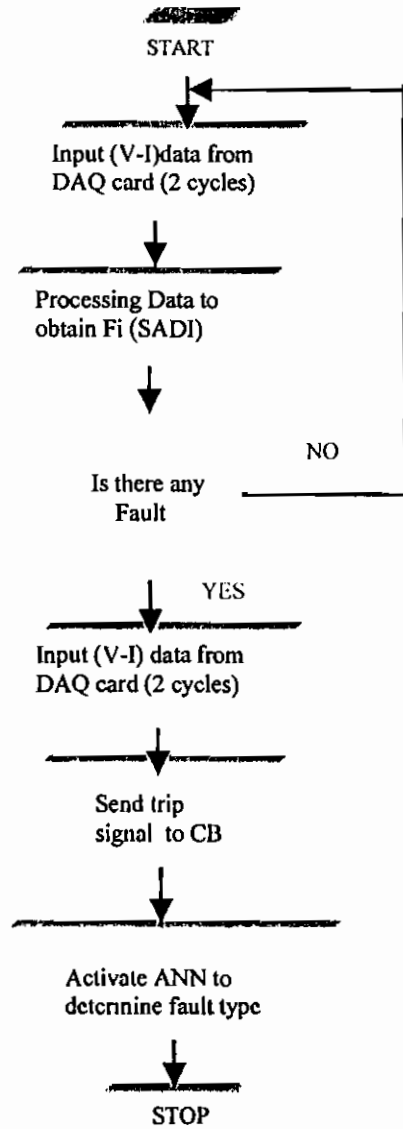

Figure7. The flow chart of the fault detection technique

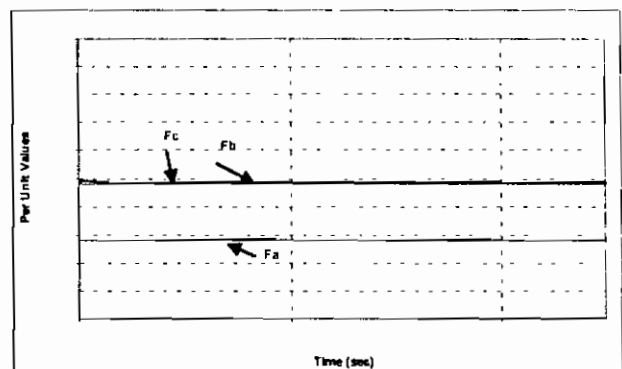

Figure8. The experimental SADI for the three phases for A to G fault.

6. Conclusions

This paper has implemented a simple technique for fault type detection of transmission line using ANN. The ANN was tested on simulated voltage and current waveforms, proving its succession. The PC is then used to monitor the voltage and current waveforms of an experimental transmission line module through a signal conditioning circuit. The ANN is then used to detect the type of fault occurring on the transmission line and the PC acted as an on-line relay to detect the type of fault and trip the transmission line. Both simulated and experimental results are correlated showing the simplicity and effectiveness of the proposed technique.

7. References

- [1] M.Kenzunovic and I. Rikalo, "Detect and Classify Faults using Neural Nets", IEEE Computer Applications in Power, October 1996, pp 42-47.
- [2] Arun G. Phadke and James S. Throp, "Computer Relaying for Power Systems", John Wiley & Sons Inc. 1990.
- [3] D.V. Coury and D. C. Jorge, "Artificial Neural Network Approach to Distance Protection of Transmission Lines", IEEE Transactions on Power Delivery, vol. 13, no. 1, January 1998, pp 102-108.
- [4] T. S. Sidhu, H. Singh and M. S. Sachdev, "Design Implementation and Testing of an Artificial Neural Network Based Fault Detection Discriminator for Protecting Transmission Lines", IEEE Transactions on Power Delivery, vol. 10, no. 2, April 1995, pp 697-706.
- [5] M. Sanaye-Pasande and H. Khorashadi-Zadeh, "Transmission Line Fault Detection and Phase Selection using ANN", International Conference on Power Systems Transients IPST 2003 in New Orleans, USA.
- [6] Thomas Dalstein and Bernd Kulicke, "Neural Network Approach to Fault Classification for High Speed Protective Relaying", IEEE Transactions on Power Delivery, Vol.10, No.2, April 1995, pp 1002-1011.
- [7] Ramachandran Venkatesan and Balasubramanian Balamurugan, "A Real Time Hardware Fault Detector Using an Artificial Neural Network for Distance Protection", IEEE Transactions on Power Delivery, Vol.16, No. 1, January 2001, pp 75-82.
- [8] Dan Hammerstrom, "Working with Neural Nets", IEEE Spectrum July 1993, pp 46-53.
- [9] Olimpa Anaya and Lara E. Acha, "Modeling and Analysis of Custom Power Systems by PSCAD/EMTDC", IEEE Transactions on Power Delivery, Vol. 17, No.1. January 2002, pp 266-272.