

COMPUTER AIDED FOUNDRY MOLD DESIGN

تصميم قوالب (السيالة) بمساعدة الحاسب الآلي

Abdel-Razek A. Aboul-Nour, Tawfik T. El-Midany*

Farouk A. Shehata, Adham E. Ragab

Zagazig University, Faculty of Engineering.

* Mansoura University, Faculty of Engineering

ازدادت أهمية استخدام الحاسب الآلي في المسابك في الأونة الأخيرة منذ نهاية الثمانينات وبداية التسعينات ، وقد قمتنا في هذا البحث بتقييم نظام جديد لبرنامج شامل لتصميم قوالب المسبوكات الرملية يمكن استخدامه في المسابك الحديدية و الغير حديدية . يستخدم هذا النظام برنامج ال AutoCAD لرسم المنتج المراد سباكته وحساب المساحة السطحية و الحجم وكذلك تقسيم النموذج الى جزئين في القالبين السفلى والعلوى ثم يقوم البرنامج المقترح بحساب أبعاد القالب العلوى والسفلى وكذلك حساب أبعاد المصعد وحوض الصب والمصببات بالاضافة الى حجم وكتلة المسبوك. هذا ويتميز البرنامج بإمكانية استخدامه مع المسبوكات الهندسية المعقدة و البسيطة الشكل ، وإجراء أية تعديلات يطلبها المصمم أو المنتج بصورة سهلة و سريعة مما يوفر المجهود و الوقت اللازم لإجراء هذه التعديلات يدويا بدون استخدام الحاسب. كما يتميز أيضا بقبول أية تعديلات في خطوات التصميم أو خواص المواد طبقا لتطورات البحث العلمى أو الاكتشافات العلمية الحديثة كما يقلل هذا النظام من الاعتماد الكلى على خبرة المستخدم حيث يمكن استخدام المعلومات المخزنة طبقا للشكل المطلوب انتاجه ، كما يتيح الفرصة لاختيار قيم أخرى للاستفادة من خبرة المستخدم اذا لزم الامر . وبذلك يقدم هذا النظام الأساس التكنولوجى لاستخدامه فى معظم التطبيقات الصناعية بصورة سهلة ومبسرة واقتصادية .

ABSTRACT

In the late 1980's and early 1990's, use of CAD/CAM and computer graphics in both ferrous and non-ferrous foundries increased considerably. An interactive computer system has been developed using an Autocad software as a base for this system. Several routines have been used to utilize the geometrical data, surface area and volume of the product drawn by the Autocad techniques. A pattern model was built and splitted at parting surface to show parts of casting in the cope and drag. It can also be viewed from any direction to check the facility of withdrawing the pattern from the molding sand. The system results in a complete planning sheet that include casting weight, core prints, flask, gating and riser dimensions. The results can be saved for any modification and new results can simultaneously be found. Some case studies were described and presented.

INTRODUCTION

In recent years much efforts have been devoted to introduce the CAD systems as a basis technology and tools for many engineering applications, a few of these efforts have been directed to foundry applications [1 - 6]. Although considerable success has been obtained, many difficulties are not yet resolved. Some approaches are costly to implement and require the use of large main frame computers. Other researchers have concentrated on modeling of fluid flow of liquid metal in casting. [7, 8]. Others worked on simulation and modeling of the solidification process or the mold filling process [9, 10]. More related works for riser calculation has been presented by Ruddle et al [11]. Ajmal & Dale [12] have presented a microcomputer program to estimate the total casting weight by using more than twenty options for basic shapes. The dimensions of each basic shape has to be entered into the computer which is rather difficult and lengthy. However, most previous efforts have focused on either fluid flow or solidification and no complete package has been presented to meet the need for both foundry and design engineers.

This paper introduces an easy and interactive software system based on using Autocad facility to be used in both design and production stages. Topics to be discussed include (i) The use of Autocad to draw and split the pattern and to calculate the surface area and volume of the casting. (ii) The development of software program that utilizes the area and volume calculations, and in addition, theoretical and empirical relations of the given casting material to find the mold, core, gating and riser dimensions.

SYSTEM DESCRIPTION

The foundry CAD system consists of two files " Casting.exe and Casting.hlp ", and one module. Casting.exe is the executable file of the main program. It's size is about 83 kbytes .The main program has been written in Basic (Microsoft Visual Basic Package). It has to be run under Windows. The program is driven by menus and controllers (command buttons, option buttons, list boxes, etc.). Casting.hlp is the help file. It contains help about every detail. It also uses the facilities of the Windows help files in searching, branching, returning back, ... etc.

In Autocad the AutoLISP language, which is an implementation of LISP within Autocad, has been used to retrieve and manipulate the drawing data from the drawing data base. The commands to access the Autocad program have been established by adding them to submenus which can be called from the main program.

System Menus Design

Figure 1 shows the system menus diagram. The opening program screen includes four menus. Each of them may be activated by clicking it with the mouse or pressing Alt. + the underlined letter. The menu elements may be activated by the same technique. Each menu element has a special subroutine to accomplish an assigned task when activated.

Program Procedure

Figure 2 shows the main program flowchart. The running procedure is as follows : When the program starts the screen is displayed as shown in Fig.3. At this point the user has two choices , i- Make design for a new casting "new run" or , ii- Retrieve data from previous saved run.

To retrieve data activate the "File" menu then choose "Open" ; a dialogue box is displayed. The user chooses the required file and press " OK" then the program automatically displays the data from the chosen file. The user now can edit any of these data by activating the "Edit" menu and select the required item from it.

The program extracts some data from the database built-in, it depending on the chosen material, casting volume, casting dimensions. These data include material density, gating ratio, standard flask dimensions, etc. The program then calculates the casting weight and cope and drag dimensions. The core prints are then chosen depending on the core diameter, length and position according to the core print standards [7]. The riser volume is also estimated according to Adams and Taylors formulas [10]. It is assumed that the riser is open and the ratio between its length and diameter equal 1 :1 . These assumptions may be changed by the user to update the system. The ingate diameter is calculated according to the fluid mechanics formulas [7]. The runner and sprue diameters are calculated as a ratio of the ingate area. The volume of pouring cup is also calculated.

The results are displayed on the screens. If the results are accepted the user can save them or end the run. If not, the user can return back to the design variables of Edit menu to suit his requirements.

To make a new design process, the user chooses "New" from "File" menu or "Start" from "Run" menu. The material screen is opened and the user can choose the material to be cast, the casting name and serial number. The material screen is shown in Fig.4. As the geometry selection element is evoked from the Edit menu, the program runs the CASTCAD module to draw a new job to be casted. The CASTCAD module flow chart is shown in Fig. 5. The procedure is as follows :

i- The user begins by drawing the casting, or open it, if it was drawn before. If the drawing is not accepted the user can edit it using the AUTOCAD editing tools. This editing process is repeated until the drawing is accepted.

ii- The program asks the user if there is any holes in the drawing. If the answer is yes the program separates the drawing entities and asks the user to select them. Holes with diameters less than 15 mm will be preferred to be rather machined than cored. The program then resolidifies the casting drawing. If the answer is no; the control goes to step iii.

iii- The program calculates the volume, surface area and overall dimensions of the casting, in addition to the diameters and lengths of the holes.

iv- The user is asked to select the parting surface by defining which plane it is parallel to XY, ZX, or YZ planes and choosing a point on this plane. The program then gets the position of the holes with respect to the parting surface. The drawing is then cut into two parts and the user is asked to choose the part in the drag. The other part will be considered automatically in the cope. The overall dimensions of both parts are calculated.

The user exits AUTOCAD to point "B" shown in the flowchart of Fig.2. To save the casting data "Save" is chosen from the "File" menu. The select file dialogue box, will be opened so the user can enter the file name and path. Choosing "Print" from the "File" menu will send all results to the attached printer. To stop a run without exiting the program select "Stop" from the "Run" menu and to exit the program choose "Exit" from the "File" menu.

Figure 6 shows the "Help" menu and its elements. Selecting "Contents" from this menu will open the contents screen, shown in Fig.7.

It should be mentioned that in selecting many of the commands will cause several prompts from the program inquiring about the casting features; (thickness coefficient, friction coefficient, gating type, riser diameter to height ratio). The reply to most of these features can be done using a mouse or a digitizer. Modification can be carried out when necessary, until the optimized results can be obtained. In the process of answering the feature value the user has two options :

1- Totally dependent on the program, by making the algorithm selects the values using the casting geometry data.

2- The user has the freedom to select any other values. The experienced users can freely input their own values.

Two case studies are presented. Figure 8 shows a bearing bracket made of cast iron. The parting surface was chosen to divide the casting as shown in Fig.9 into two parts in drag & cope. Holes less than 15 mm will be drilled so we have only one vertical core. Figure 10,a-d shows different screens for the required results. Figures 11 - 13 shows the editing screens for gating , riser and core respectively. Figure 14 shows the other case study for a casting made of steel without any cores. This casting will be casted completely in the drag . Figure 15,a - c shows different screens for this casting.

CONCLUSIONS

A comprehensive foundry CAD system has been developed that can design riser, gating and mold for wide variety of casting metals and cross sections providing low cost, fast and accurate method.

Most of the geometrical sophisticated shapes can be treated with this program. The results of this system have shown good ability to interact with both foundry and design engineers and the resulting flexibility greatly enhances the industrial applications of the system. It reduces the amount of work that is normally required when the mold design is carried manually, and is particularly suitable for use with microcomputers.

Automating the process of mold design will lead all users to the same design details regardless their skills or experiences. The system also allows the users to modify their designs according to the most recent researches on design parameters or material specifications. This is easily done through the "Edit" menu and "Edit" screens.

REFERENCES

- 1 - N. Sirilertwoyakul, P.D. Webster, and T.A. Dean, "A software package for the design and production of castings", Vol.9, PP 365-366, Materials Science and Technology, October, 1993.
- 2 - R.A. Stoehr, C. Wang, W.S. Hwang, and P. Ingersler, "Modeling the filling of complex foundry molds", PP 303-313, 3rd Int. conf. on modeling of casting, Santa, California, January 12-17, 1986.
- 3 - Manfred K. Walther "Experimental verification of C.A.S.T.", PP 345-359 3rd Int. conf. on modeling of casting, Santa, California, January 12 - 17 1986.
- 4 - Freddy Syversten "CAD/CAM in the foundry", PP 387-401, 3rd International conference on modeling of casting, Santa, California, January 12 - 17 1986.
- 5 - Jong Cheon Park, Kunwoolee, "Computer aided design of pattern and risers for casting processes & Computer aided design of a mold cavity with proper rigging system for casting processes", Vol. 113, PP 59-66, Journal of Engineering for Industry, February 1991.
- 6 - Abdullah A. Ajmal, "The development of a computer aided process planning and estimating system for use in a jobbing foundry", PP 589-597, 9th Industrial conference on Production Research, Cincinnati, OH, USA, 1987.
- 7- Sha W. T. "Fluid flow modeling in casting processes and its implication", PP 397-409, 4th Int. Conf. on modeling of casting & welding process, Palm Coast, Florida, USA, 17 - 22 April 1988.
- 8- Domaus H.M., Liu Y.Y. & Sho W.T. " Fluid flow modeling in casting process " 3rd Int. Conf. Santa Barbara, California USA, 12 - 17 January, 1986.

- 9- Hansen P.N. & Sahm P.R. " Simulation modeling for advanced solid processes " 4th Int. Conf , Palm Coast, Florida, USA, 17 - 22 April 1988.
- 10- Wang J. , Hansen S.F., Hansen P.N. "3-D Modeling and simulation of Mold filling ", 4th Int. Conf , Palm Coast, Florida, USA, 17 - 22 April 1988.
- 11- Ruddle K.W., Suchil A. L., " Riser sizing by microcomputer" Eng. foundation conf on Modeling of casting and welding process II , Newyork, USA, 31 July - 5 Aug. 1983.
- 12- A. Ajmal, B.G. Dale, "Amicro-computer aided interactive process planning and estimating system for use in a jobbing foundry", PP 491-501, Proceedings of the 1st National conference on production research, University of Nottingham, U. K., Kogan Page, 1986.

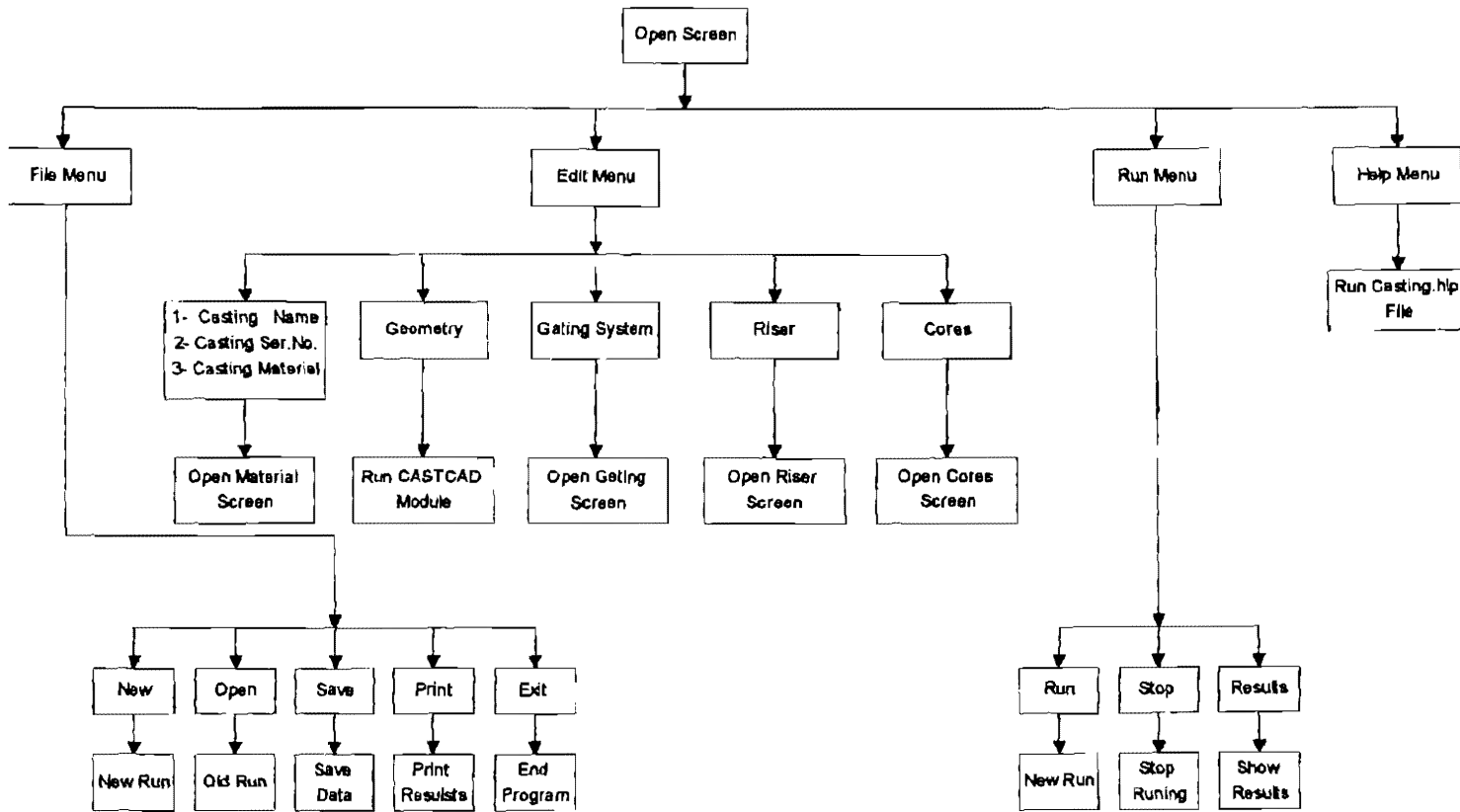

Fig. 1 Menu System Diagram

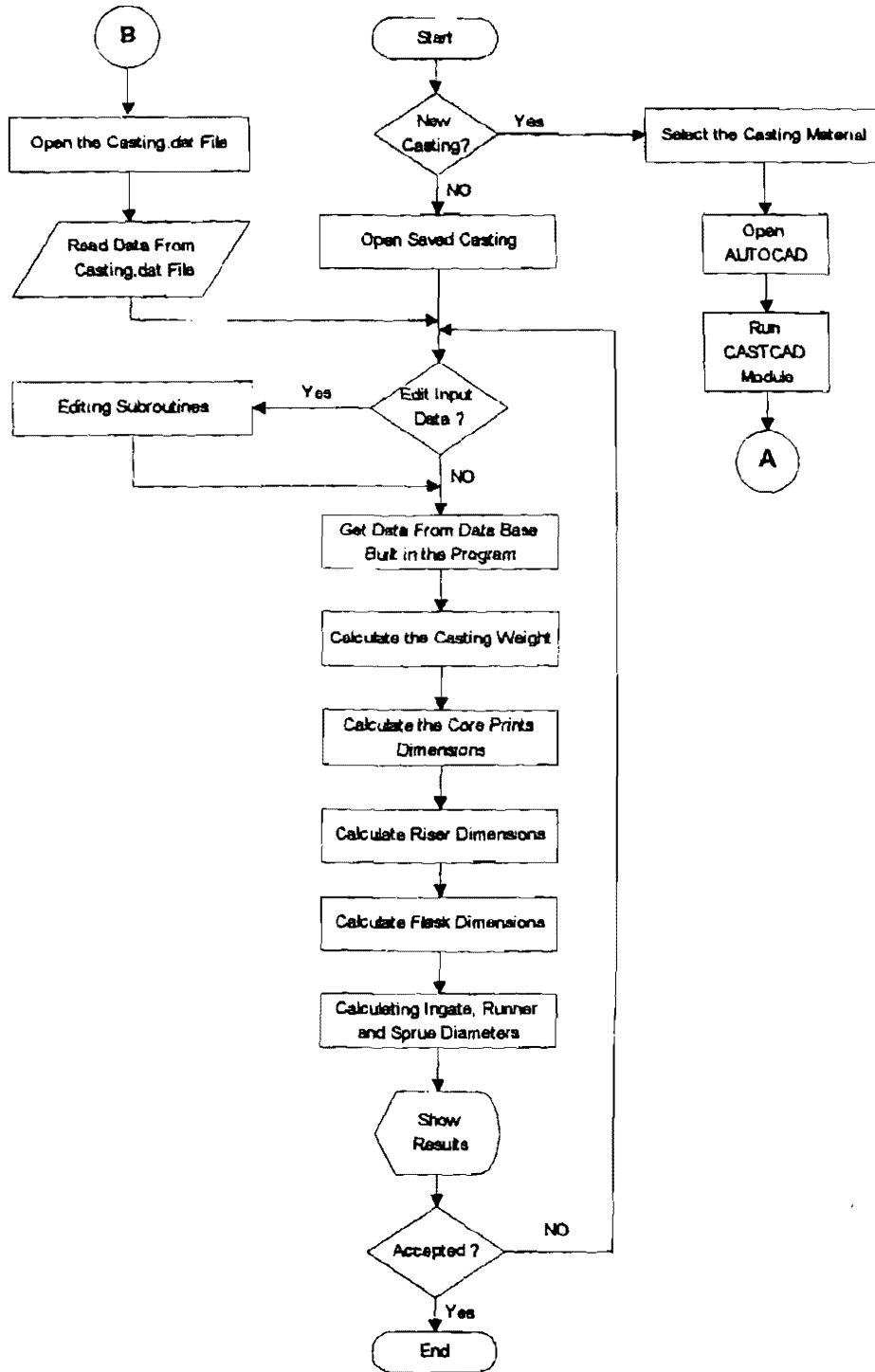

Fig.2 Program Folwchart

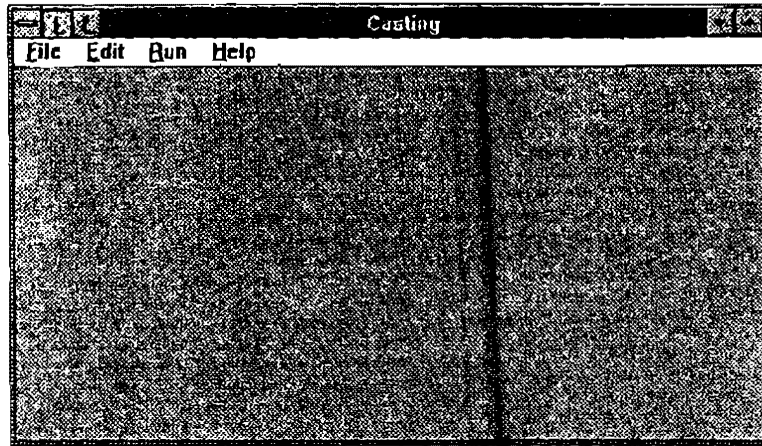

Fig. 3 Open Screen

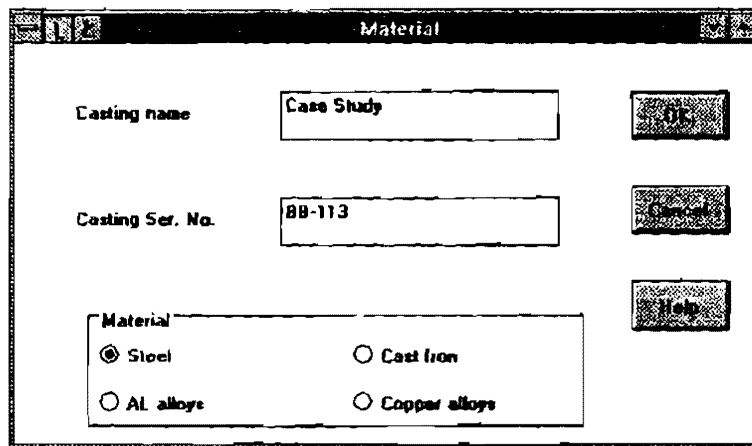

Fig. 4 Material Screen

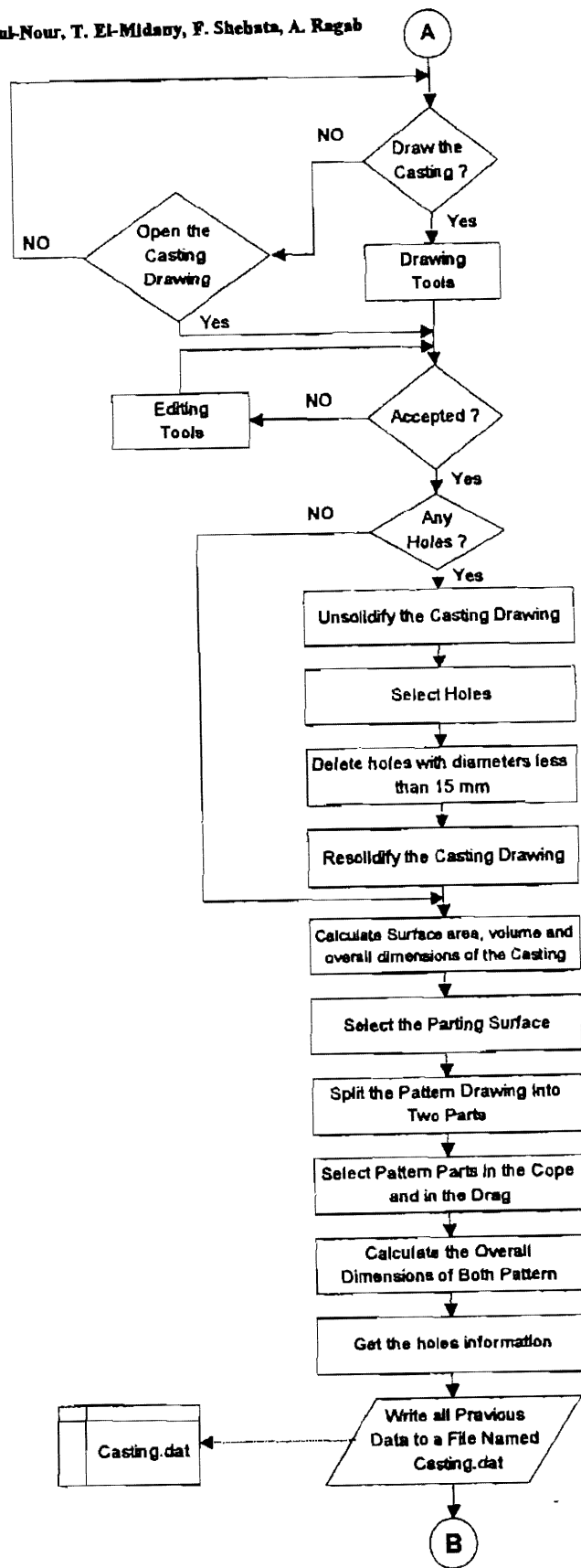

Fig. 5 CASTCAD Module Flowchart

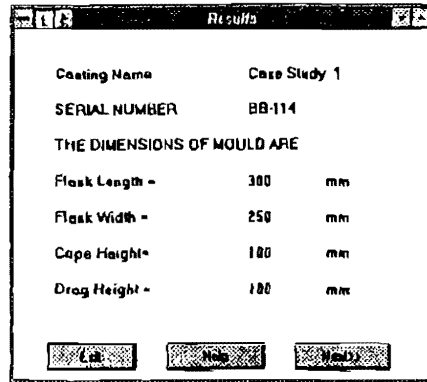

Fig (10 - a) Results Screen No.1

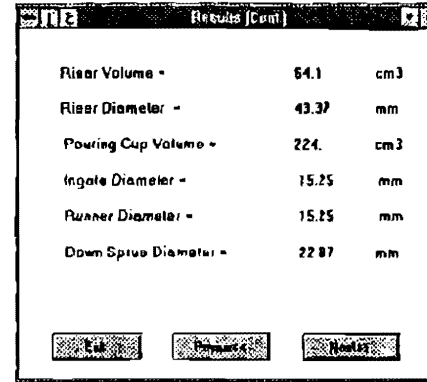

Fig (10 - b) Results Screen No.2

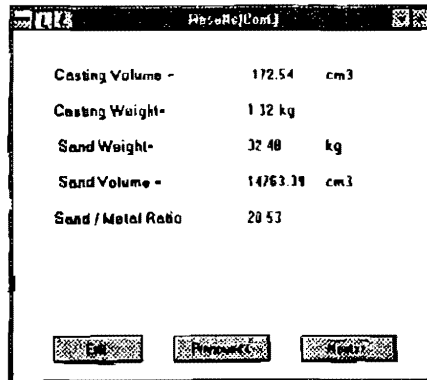

Fig. (10 - c) Results Screen No. 3

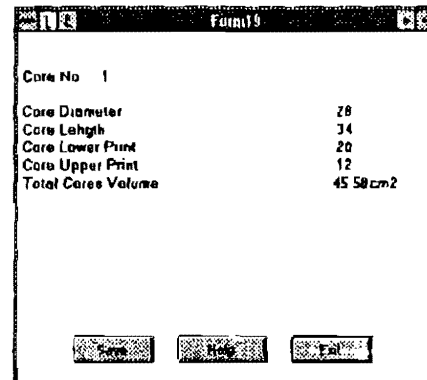
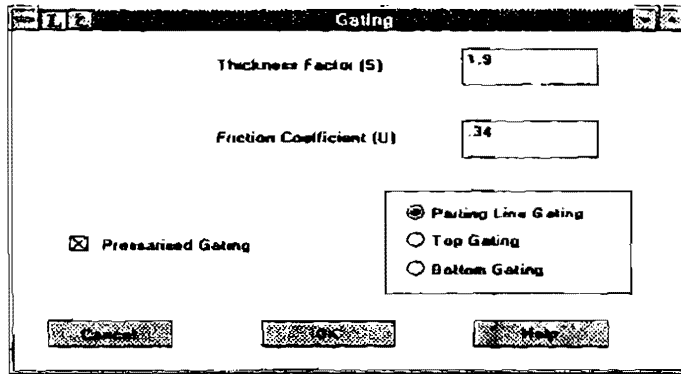
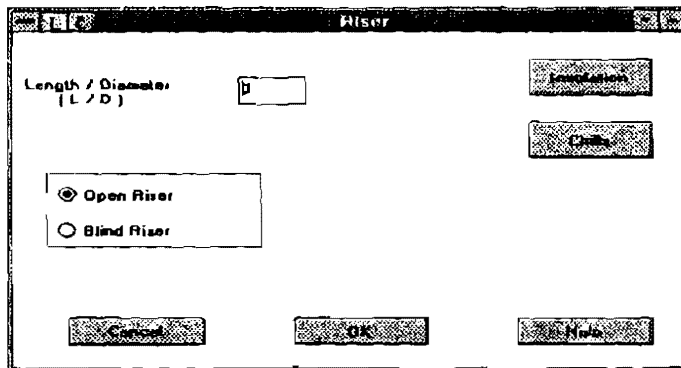

Fig. (10 - d) Results Screen No.4



The Gating screen features a title bar with standard window controls. It contains two input fields: 'Thickness Factor (S)' with the value '1.9' and 'Friction Coefficient (U)' with the value '.34'. A checkbox labeled 'Prearranged Gating' is checked. A group box contains three radio buttons: 'Parting Line Gating' (selected), 'Top Gating', and 'Bottom Gating'. At the bottom are 'Cancel', 'OK', and 'Help' buttons.

Fig 11 Gating Screen



The Riser screen has a title bar with window controls. It includes a 'Length / Diameter (L / D)' input field with the value '1'. To the right are 'Cancel' and 'OK' buttons. A group box contains two radio buttons: 'Open Riser' (selected) and 'Blind Riser'. At the bottom are 'Cancel', 'OK', and 'Help' buttons.

Fig. 12 Riser Screen

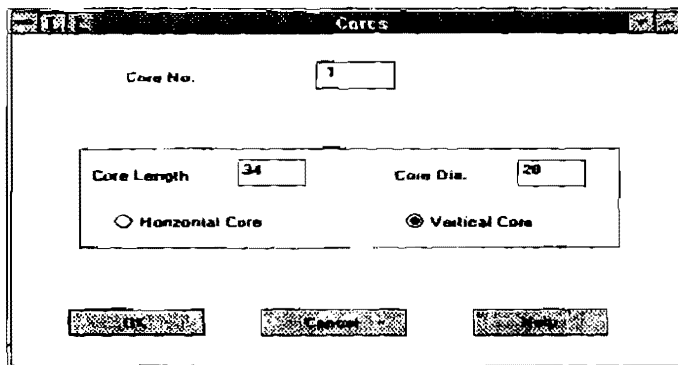

The Cores screen features a title bar with window controls. It has a 'Core No.' input field with the value '1'. Below this is a group box containing two input fields: 'Core Length' with the value '34' and 'Core Dia.' with the value '20'. The group box also contains two radio buttons: 'Horizontal Core' and 'Vertical Core' (selected). At the bottom are 'OK', 'Cancel', and 'Help' buttons.

Fig. 13 Cores Screen

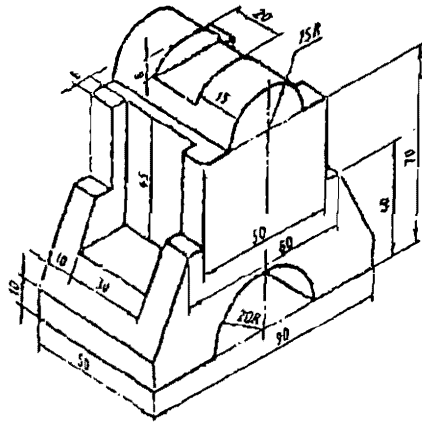

Fig. 14

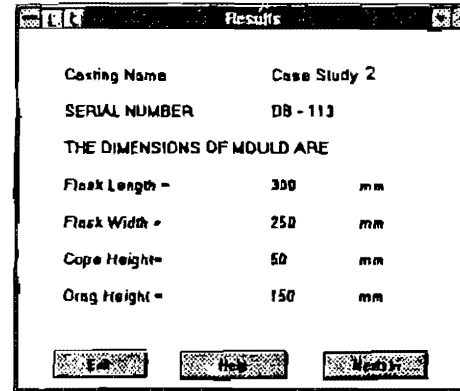

Fig. (15 - a) Results Screen No.1

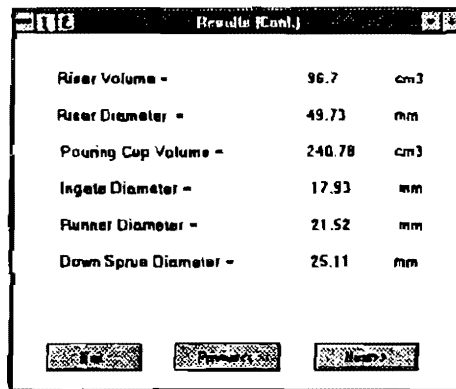

Fig. (15 - b) Results Screen No.2

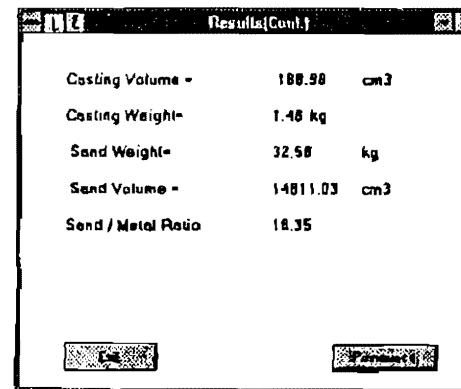

Fig. (15 - c) Results Screen No.3