

THE HAND PEDAL TYPE WITH RECIPROCATING SHELLER PLATE TO SHELL CORN

EI-Hanfy, E. H.

Inst. For Efficient Productivity, Zagazig Univ., Egypt.

ABSTRACT

The aim of present paper is to construct, design and evaluate corn sheller to achieve shelled kernels with highest efficiency and lowest damage in proper time. Those, the reciprocating shelling plate is investigated to reduce the kernel movement in varies direction inside the prototype consequentially decrease the kernels damage. The experimental prototype consists of the main frame consists of three similar cub units (holding device), shelling plate and the inversion of slider crank chain mechanism regulated with four different crank radii (4.5; 6.5; 8.5; 10.5 cm). The un-depended variables were different levels of reciprocating cycles, three levels for each of shelling teeth number, clearance and reciprocating shelling plate times at different crank radii. The shelling plate speed (m/s) was recorded relative to the angular speed of connecting shelling plate with the end point of crank radius. All experiments were carried out under constant kernel and cob ear moisture content "MC" of 10.8% and 10.32 "wb" respectively. The study gives the indicator to judge and deduce that the best factors which gives the highest shelling efficiency (98.8%) and the highest productivity (78.392 kg/h) were 100 number of shelling teeth, 25mm clearance, 105cm crank radius and 65.4cycle/min shelling plate reciprocating. On the other hand, the external and internal cracks of the shelled corn are low percentage.

INTRODUCTION

Corn is one of the more important cereal crop growths in the world and especially in Egypt. Particularly, it is one of major staple human food crops. On the other hand, it constitutes about 50% of the feed ration for livestock and poultry production. In the small Egyptian farms, the corn is shelled by rubbing the maize cobs against one another by hand or by direct removal of the kernels with one's fingers. This is very tedious, extra time and labor consuming and thus too expensive. Therefore, corn shelling machines are one of the most convenient and labor-saving implements that the practical farmer has in use. Thus, the quest for a satisfactory cheap effective means of detaching the kernels from the cobs, so replacing such traditional shelling-techniques, is of importance for small and even medium-size farms in Egypt. The threshing process depends on the maize variety characteristics, the design and structure of the threshing apparatus, and its adjustment. Kravchenko and Kuceev (1979) determined that adhesion between a grain and the maize cob depends on the grain moisture content and its location on the ear. While, Inglet (1970) stated that shelling is difficult to achieve properly at a moisture content of the kernels exceeding 25% (wb). Above this, the extracted kernels tend to have suffered considerable damage during the process. When the maize has been dried to between 13% and 14% (wb), it is easier to shell (Adegbulugbe, 1986 and Adewale *et al.* 2000). It's because the kernel breakage rate increases with moisture content above 14% (Alonge *et al.* 2000). Also Dirk (1996) stated that the kennels and cobs were equilibrium at kernel moisture content 13%.

Gore *et al.* (1990) classified the shelling power source into manually and power-operated. Based on shelling action, the sheller may be classified into reciprocating and continuous or rotary types. Petkevichius *et al.* (2008) states that grain losses during the threshing exceed the permissible level as the ear moved through the concave, rotated about its axis and jumped, also the grains moved longer distance. While, Sudajan *et al.* (2002) indicated that the grain damage increased with an increase each of drum speed and feed rates. This increase was due to higher impact levels transmit to the crop during threshing at higher drum speeds. Ismail (1988) studied the effect of some operating factors such as clearance, shelling speed and number of beaters on damage and machine efficiency. The results showed that the number of beaters increased corn kernel damage increased.

Vindizhev and Blaev (1983) were indicated that the ear diameter decreases during the threshing, thus, the clearance at concave end should be less than that at the concave front. While, Nimfa and Alexis (2009) point out that there are several shellers commercially available mostly important of them is the crushing type with high capacity sheller. However, in terms of suitability to the small holding areas, this sheller may be unsuitable due to it's more costly to operate and also for seeding purpose due to the relatively higher degree of external and internal cracks of the shelled corn output.

From the previous reviews, the corn shelling machines by conventional methods (drum-concave or drum rasp-bars) recorded exceed the permissible levels of grain losses and un-shelled corn as the ear moved through the concave. So, this paper aims to:-

- 1- Investigate the hand pedals types as easy implement operating in small farm size.
- 2- Using the shelling theories to shell the kernel from ear using reciprocating vertical plate.
- 3- Construct and evaluate the reciprocating sheller to perform corn shelling with highest shelling efficiency, lowest un-shelling and losses in proper time.

MATERIALS AND METHODS

The manual reciprocating corn sheller was constructed in the Agricultural Engineering workshop, faculty of Agriculture, Mansoura University as shown in Fig. 1. The following points were taken into consideration during the construction:

- 1- The constructed sheller should have a simple mechanism.
- 2- The sheller prototype may be reducing the grain crushing wherein spent cobs remain whole after shelling.
- 3- The investigated prototype may be operating by anyone without instruction.

The experimental prototype consists of the main frame made of mild steel angle section (50×50mm and 5mm thickness) that design to easy set in stool and having stable balancing during rotated by hand. The inversion of slider crank chain mechanism identify with four different crank radii. In the upper prototype, the shelling plate was located with the holding device (Fig. 2).



Fig. (1): The shelling corn prototype



Fig. (2): The shelling plate and the holding device

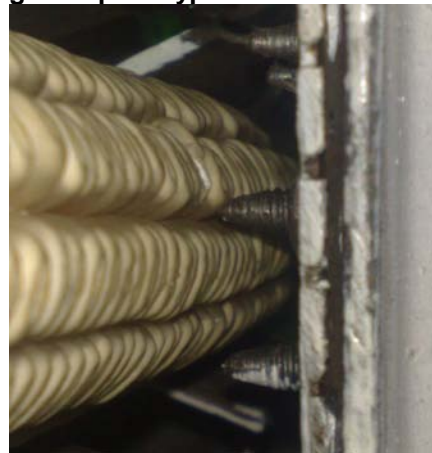
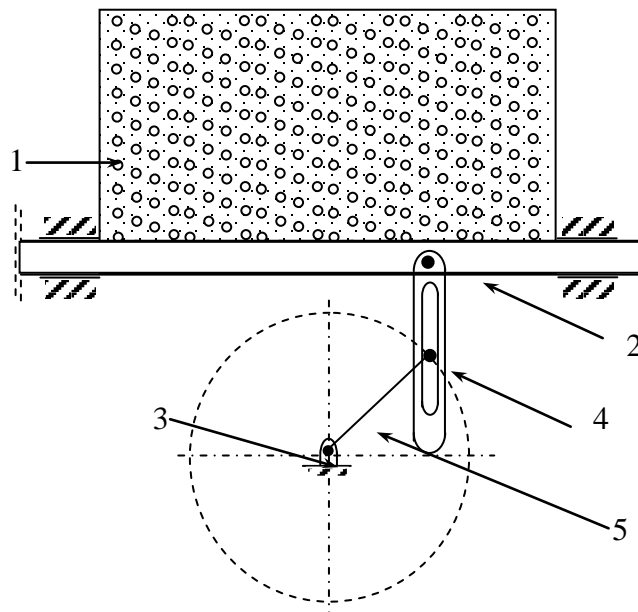

Fig. (3): The shelling teeth shape

- 1- Holding device:** there are three similar cub units located on the prototype frame. Every unit contain stationary concave compartments segment of a tube with its concavity shape that facing the shelling plate. The cub was constructed from steel of 2mm thickness, cut to accommodate the maximum length and diameter of the corn ear to facilitate their firmly contact against shelling plate. The diameter at the concave end less than that at the front to avoid throwing cobs after shelling into chute with kernels and to facilitate remove it's from holding units.
- 2- The holding device frame:** It was fixed on the main frame of prototype by using four bolts that moving in perpendicular direction to adjustment the clearance between shelling plate and holding device.
- 3- Shelling units:** It consists of reciprocating plate with 5mm thickness of sheet plate. It provided with number of teeth (Fig. 3). There were

distributed on the surface of shelling plate with protruding of 10-15mm and 20 mm a part.

- 4- **The motion:** It was supply to prototype by rotating the hand of pedals that turning the crank which pushes the connecting rod of the slider block. The motions transform to slider flat bars by means of the connecting rod (Fig. 4), then the reciprocating motion of the slider pushing the shelling plate. To improve the handle motion, it covered with a freely rotating pipe, is provided for energizing the machine.
- 5- **The description of prototype work:** The transmission motion from hand pushing to shelling plate was regulated by changing the crank radius. The ears rotate about vertical cobs axes in proportional motion with reciprocating shelling plate which reciprocating (recycling) with greater rapidly than the rotating ears therefore bringing all parts of the ear under the action of the shelling teeth.



- 1- shelling plate 2- reciprocating bar 3- connecting hand of pedal
4- connecting joint 5- connecting arm of mechanism

Fig. (4): The shelling prototype layout

Methods

Biometric indicators of corn ears were determined by measuring the length and diameter of 100 ears and counting the number of vertical and horizontal grain rows. The variety of maize under lab experiments was Trabel Hoogen 324. The grains mass (measurement accuracy of 0.1g) was evaluated at definite moisture content. The moisture of kernels and cobs has been determined by heating in the drying oven for 16h at 130c° (AOAC, 1970).

The experimental variable

- 1- **The reciprocating cycles:** Four levels of reciprocating cycles were changed during failing the experiment. There were regulated by changing the crank radius (45; 65; 85; 105 mm).
- 2- **The shelling teeth number:** Three levels of shelling teeth number (100; 125 and 150) were investigated. Each level of teeth was distributed to cover the ear project area during full stroke.
- 3- **Shelling plate reciprocating (S_{pr} , cycle/min):** The one revolution of crank hand recorded one cycle of reciprocated shelling plate, and then the number of hand rotation was recorded and divided on the operation times.
- 4- **Shelling plate speed:** The shelling plate speed (V , m/s) was recorded relative to the angular speed of connecting shelling plate (ω) with the end point of crank radius (R , mm), that can calculated from the following equation:

$$V = \omega^2 R$$

- 5- **The clearance between the holding device and shelling plate:** Under experiments three of shelling clearances were 25; 30 and 35mm.
- 6- All experiments were carried out under constant kernel and cob ear moisture content "MC" of 10.80% and 10.32% "wb" respectively. These values was agreement with Dirk (1996) which stated that, the kernels and cobs were equilibrium at kernel "MC" 13%. Also, the operation force on the pedal hand during all treatments was considered as constant value.

General shelling unit performance

The four criteria used to evaluate the performance of the sheller in the laboratory were: shelling efficiency; un-shelling kernel in percentage, kernel damage and prototype productivity.

- 1- The shelling efficiency (E_{sh}) in % was calculated from the expression:-

$$E_{sh}, \% = \left(\frac{a}{a + b} \right) \times 100$$

Where: a = is the mass of separated kernels in g; and
 b = is the mass of un-separated kernels in g;

- 2- Un-shelling kernel percentage (K_{uh}) was evaluated from the following equation:

$$K_{uh}, \% = \left(\frac{b}{a + b} \right) \times 100$$

- 3- Kernel damage, the mass of visible and invisible damage of maize kernel (K_d) were calculated in percentage as follows:

$$K_d, \% = \left(\frac{K_v}{a + b} \right) \times 100$$

Where: K_v = the mass of visible and invisible damage of maize kernel, g

- 4- Sheller productivity was calculated for all treatments under study by feeding corn batches (15 ears per every treatment) to holding device.

After the kernels shelled there were collected and massed. Also, during shelling operation the shelling times were measured. Then the following relation was used to determine the productivity:

$$P = \left(\frac{M \times 3600}{t} \right) \quad \text{kg h}^{-1}$$

Where: P = the productivity in kg h⁻¹

M = mass of shelled kernel in kg

t = time in sec

All data collected for all parameters of different treatments were statistically analyzed. Statistical analyses included analysis of variance, stander deviation and least-significant difference (LSD).

RESULTS AND DISCUSSION

Biometrical indices of corn ears

The biometric index of corn ears varieties (Trabel Hoogen 324) grown in Egypt, was measured to determine the main parameters of the threshing prototype are shown in table (1). In our investigation, the most important biometric indices are the diameter of corn ear and its cob than the ear length. Because of the diameter at bottom of the concave tube of the holding device must be less than at the top part and also to determine the clearance between holding device and shelling plate. The length of ear was identified to determine the longitudinal length of the holding device. The stander deviation for diameter and ear length was found ± 0.2 and ± 2.0cm respectively. Corn ears were shelled at kernel moisture content (wb) of 10.83 % its probability easier to shell this is agreement with Adewale *et al.* (2000).

Table (1): The biometric indices of corn ear

Ear	Bas diameter, cm	4.84 ^{± 0.2}
	Medium diameter, cm	4.57 ^{± 0.225}
	Top diameter, cm	3.6 ^{± 0.1}
Cob	Bas diameter, cm	3.14 ^{± 0.15}
	Medium diameter, cm	2.86 ^{± 0.05}
	Top diameter, cm	2.12 ^{± 0.06}
Ear length		22 ^{± 2.0}
No. of vertical grain rows		47.2 ^{± 3.0}
No. of horizontal grain rows		12.8 ^{± 1.5}
Moisture content	Cob	10.32 ^{± 0.189}
	kernels	10.83 ^{± 0.0577}

The shelling teeth numbers (t_n)

The levels of teeth number on the shelling plate per project surface of corn ear were distributed to shell the corn ear. The experiments are carried out to form a good judgment of corn shelling efficiency as depended variables on the teeth parameters for the shelling prototype. The increment of shelling plate reciprocating (S_{pr}, cycle/min) regarded to corn shelling efficiency (E_{sh}, %)

illustrates in Fig (5-A) at different shelling teeth numbers. The general trend of above relation is that increasing the shelling plate reciprocating increases the corn shelling efficiency until the maximum values of shelling, then the relation come to decreases at all different of shelling teeth number. The wide limits for the independent variables using 100 teeth numbers ranged from 60 to 70 cycle/min of shelling plate reciprocating at different shelling clearance. Whereas, for the above treatments were from 50 to 60 and from 45 to 55 cycle/min at 125 and 150 teeth respectively. The highest values of shelling efficiency (98.98%) recorded at reciprocating of shelling plate of 63.5 cycle/min with shelling clearance of 25 and teeth numbers of 100. The corresponding results for the un-shelling percentage as shown in Fig. (5-B) are similarly with the inverse trend for shelling curves.

The time of reciprocating shelling plate

The relationship among the reciprocating of shelling plate time and shelled kernels and un-shelled efficiency are conformed in Figs. (6-A and 6-B) respectively at three levels of teeth number during three different of shelling clearance. The figures indicated that under reciprocating shelling time of 0.88; 0.90 and 0.93 sec, the best results are found 79; 82 and 98% of shelling efficiency obtained using 100 teeth on the shelling plate. With 125 shelling teeth accompanied by reciprocating shelling time of 1.0 to 1.1 sec, the acceptable shelling efficiency result was obtained (65% to 92%). It may be due to that the resting time between corn ear and the reciprocating shelling plate is reduced. On the other hand, at shelling teeth of 150 the shelling efficiency were 65 to 91% obtained under shelling clearance of 25; 30 and 35mm respectively. While, reciprocating shelling time of 0.88; 0.90 and 0.93 sec, the best results are found 21; 18 and 2% of un-shelling percentage obtained using 100 teeth on the shelling plate (Fig. 6-B). The above trend gives the indicator to judge and chase the best teeth number was distributed on shelling surface. Thus, the 100 number of teeth considered the most appropriate number.

The crank radius of shelling device

The relationship between the shelling efficiency of corn and crank radii at different shelling plate clearance (25; 30 and 35 mm) and average different of reciprocating (49.4; 55.6 and 65.4 min^{-1}) are illustrated in Figs. (7-A and 7-B). Generally, the resulted point out that, increasing the crank radius of operating mechanisms increases the grain shelling efficiency and vice versa for un-shelling efficiency.

For example, at average reciprocating of shelling plate (65.4 min^{-1}), the shelling efficiency increased about 1.18; 1.25 and 1.38 times at 25; 30 and 35mm shelling plate clearance respectively. On the other hand, the maximum shelling efficiency were recorded at lowest shelling clearance. For example the shelling efficiency is 98.98; 88.94 and 77.15 at shelling clearance of 25, 30 and 35mm respectively during regulating the crank radius on 105mm.

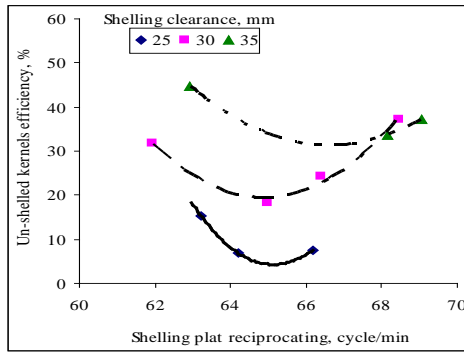
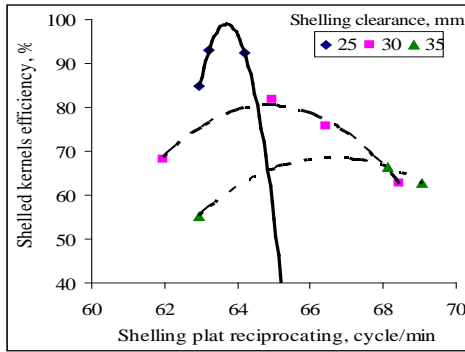

Number of distributed teeth 100

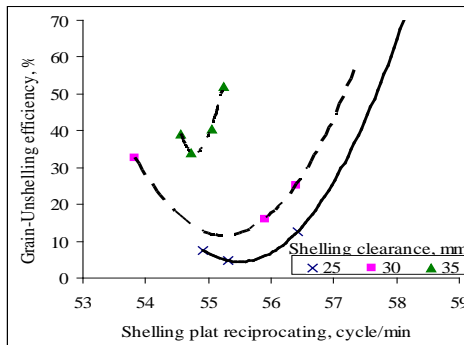
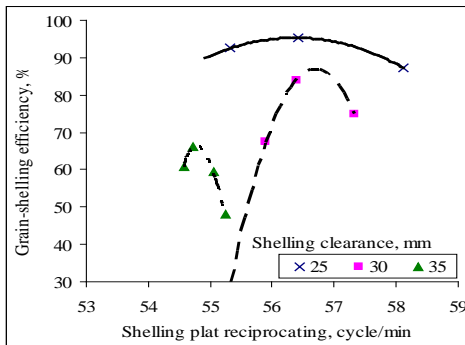

Number of distributed teeth 125

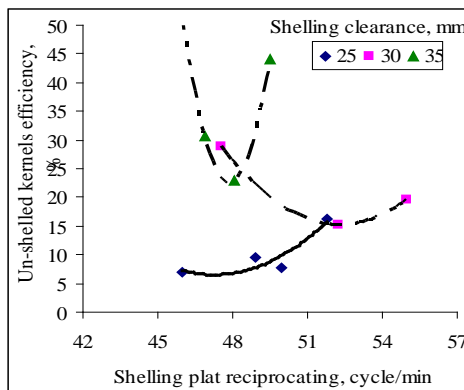
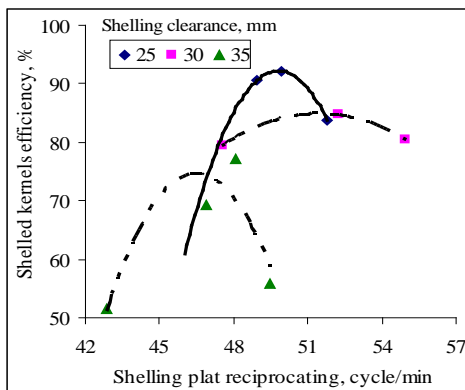

Number of distributed teeth 150

Fig. (5-A): The shelling grain efficiency via the shelling plate reciprocating

Fig. (5-B): The un-shelling grain efficiency via the shelling plate reciprocating

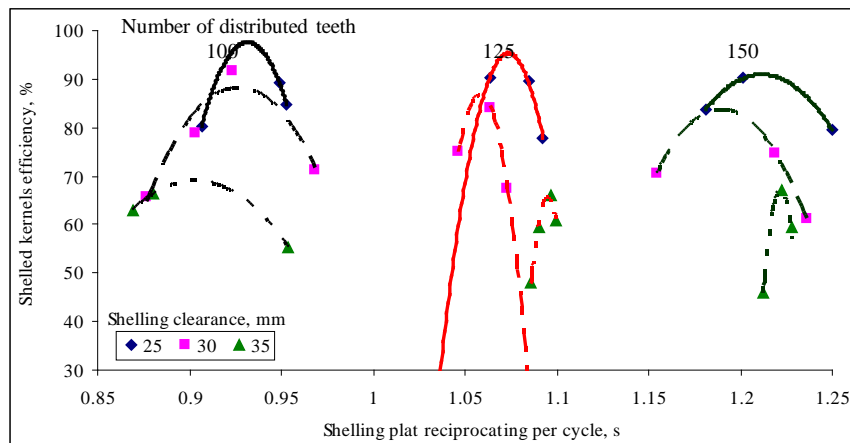

Fig. (6-A): The shelling and un-shelling kernel efficiency vi the time of reciprocating shelling plate.

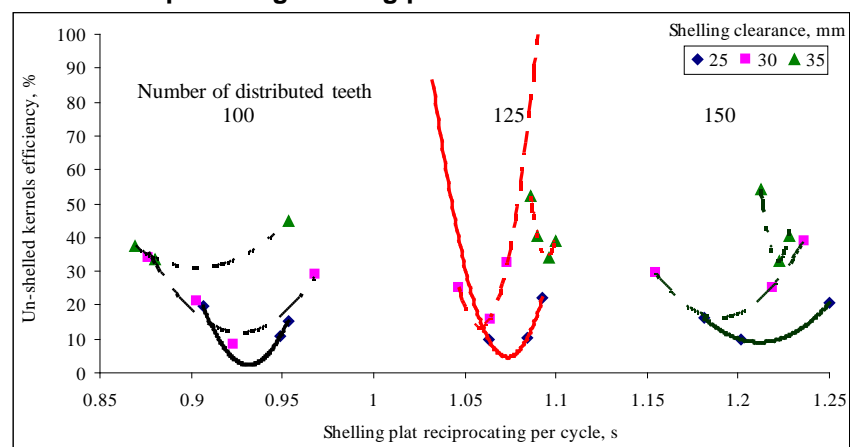
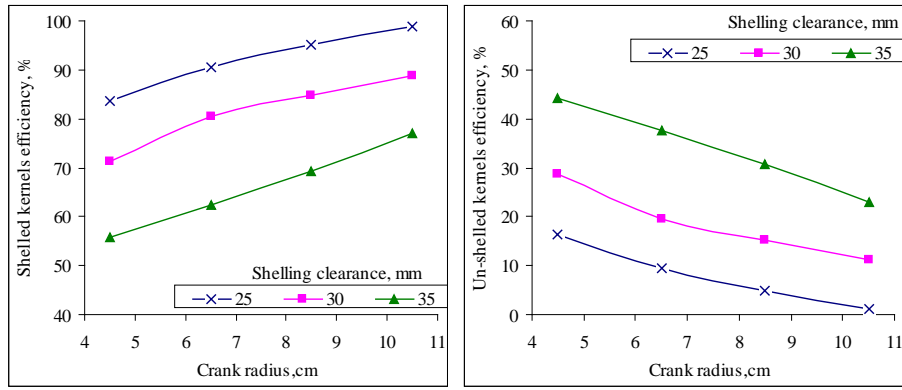

Fig. (6-B): The shelling and un-shelling kernel percentage vi the time of reciprocating shelling plate.

The shelling plate speed

The others indicator used to evaluate the performance evaluation of the shelling kernel device are presented in Fig. (8). the reciprocating speed of shelling plate was evaluated as the dependent variables function on the shelling and un-shelling efficiency (Fig. 8 A and B) at differences each of plate clearance and reciprocating variables. The results of above relation indicated that, increasing the shelling plate speed, increases the shelling efficiency while, decreases the un-shelling efficiency. The results indicated also that the highest value of shelling efficiency was 98.98% when the shelling speed of 10.2m/s, shelling plate clearance of 25mm and average reciprocating of shelling plate (65.4 cycle/min).



At average reciprocating of shelling plate (49.4 cycle/min)

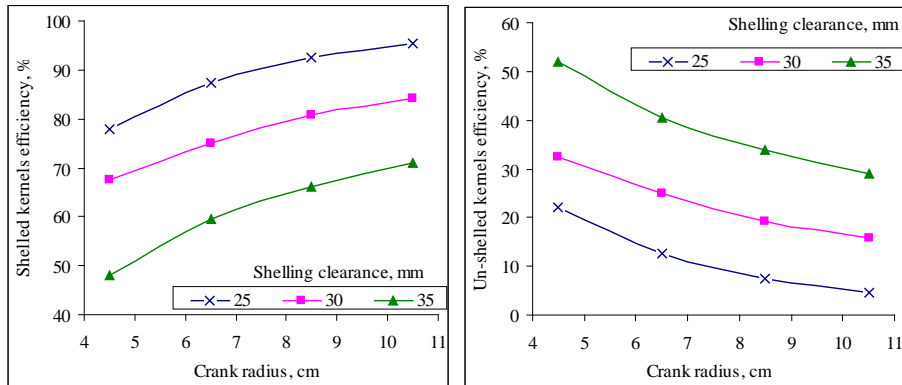

At average reciprocating of shelling plate (55.6 cycle/min)

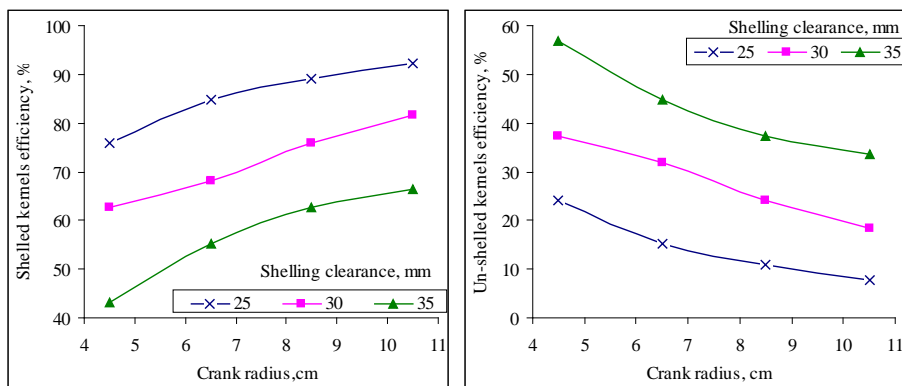

At average reciprocating of shelling plate (65.4 cycle/min)

Fig. (7-A): Effect of crank radius on the kernel-shelling efficiency.

Fig. (7-B): Effect of crank radius on the un-shelling percentage.

Kernel damage

The mass of visible and invisible damage of maize kernel (K_d) were identified. The threshed kernels were collected into kernels collector weighed, the damage kernels were separated, and the average kernel visible and invisible damage were estimated. Data showed that non-significant increase in kernel damaged at increasing shelling plate speed and reducing clearance during the highest crank radius. Generally, this percentage was lower than permissible level 0.5% with all treatments under study according to Petkevichius *et al.* (2008). Therefore these percentages can be neglected.

The prototype productivity

The average means of the prototype productivity for detached kernels under each of the shelling parameters are presented in the Fig. (9). The Fig. showed that significant differences in the prototype productivity respect to the crank radii at three different of clearance values (25; 30 and 35mm) for three of reciprocating shelling plate (cycle/min). Generally, at all reciprocating shelling plate, the highest crank radius with the lowest clearance give the chance for the corn ears projected area to shell.

Consequently, the more kernels were detached and giving high productivity. For example, the highest productivity of detached kernels was 78.392kg/h obtained at 25mm, 10.5cm and 65.4cycle/min clearance, crank radius and reciprocating shelling plate respectively. Whereas, the lower value of productivity (27.815 kg/h) was found at reciprocating shelling plate of 49.4 cycle/min with corresponding lower crank radius and the highest clearance values of 4.5 cm and 35 mm respectively, it may be attributed to the lowest crank radius and highest clearance respectively which results to the lowest of the area for the corn ears to present themselves for shelling. The previous study gives the indicator to judge and deduce that the best factors which gives the highest shelling efficiency (98.8%) and the highest productivity (78.392 kg/h) were 100 number of shelling teeth, 25mm clearance, 10.5cm crank radius and 65.4cycle/min shelling plate reciprocating.

The optimization of shelling factors:

The general multiple regressions for the interaction between the operating parameters against the shelling efficiency ($E_{sh},\%$) may be conformed as the following equation:

$$E_{sh} = 0.00081 \left(\frac{\sqrt{R} \times \sqrt{S_{pr}}}{C_r^3} \right), \quad \% \quad R^2 = 0.94$$

Where: S_{pr} = The shelling plate reciprocating cycle/min
 R = crank radius, m
 C_r = Clearance, m
 0.00081= the constant factor, $m^2.s$

The above equation can be used to predict the changes in the percentage of shelling efficiency as the interaction between shelling plate reciprocating, crank radius and clearance. The relationship between observed shelling kernels efficiency and the calculated in a 45° linear diagram are illustrated in Fig. (10), From figure can be conclusion that the

above equation have a good indicator to quick determine the shelling efficiency in percentage.

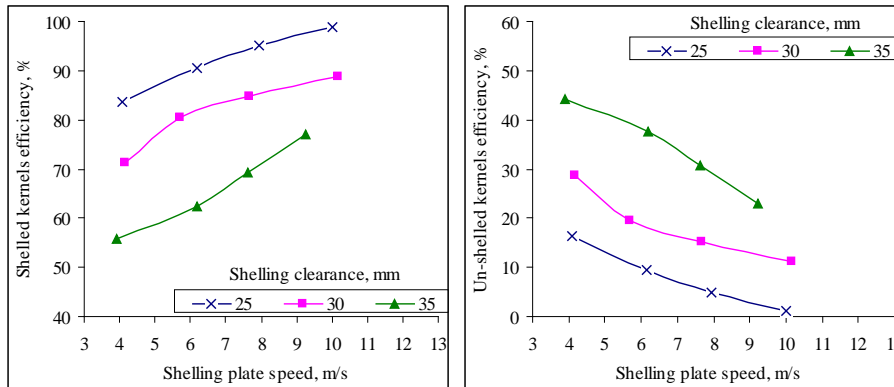

At average reciprocating of shelling plate (49.4 cycle/min)

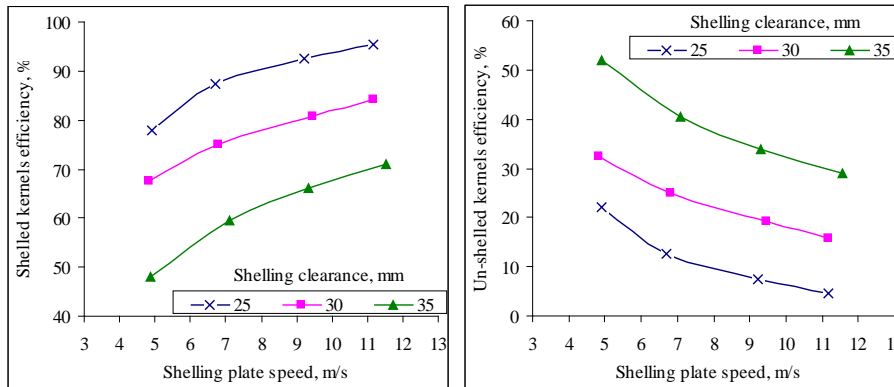

At average reciprocating of shelling plate (55.6 cycle/min)

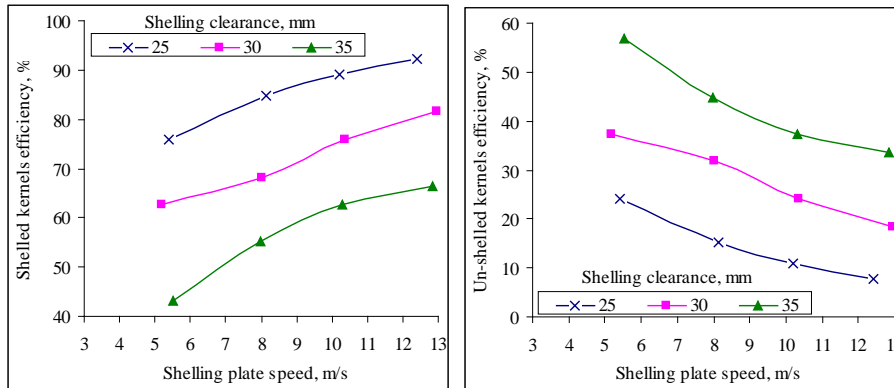

At average reciprocating of shelling plate (65.4 cycle/min)

Fig. (8-A): Effect of shelling plate speed on the grain-shelling efficiency.

Fig. (8-B): Effect of shelling plate on the grain-unshelling efficiency.

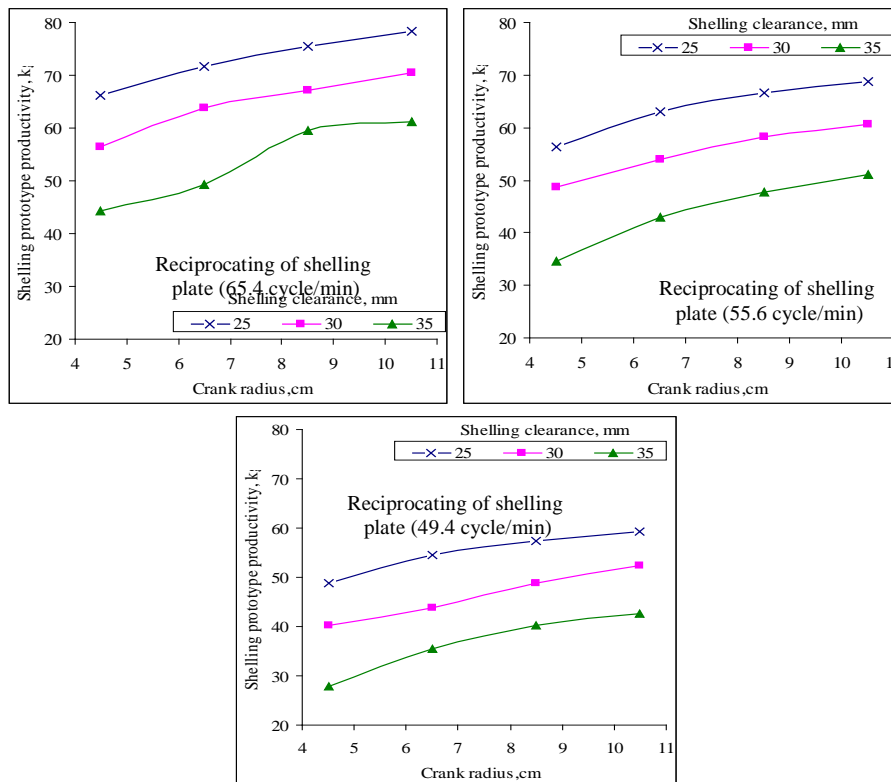

Fig. (9): Effect of crank radius on the prototype productivity

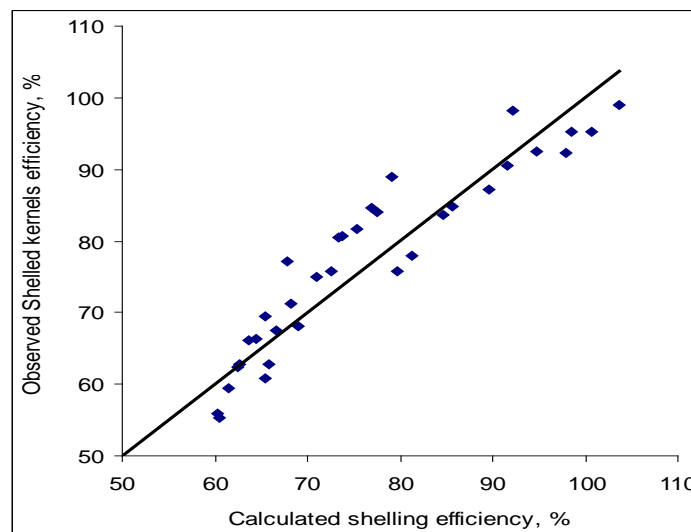

Fig.(10): A typical 45° plot of the observed and the calculated shelling kernels efficiency

REFERENCES

- Adegbulugbe, T.A. (1986). Handbook on the construction of maize-shellers, Institute of Agricultural Research and Training, Moor Plantation, Ibadan, Nigeria.
- Adewale, A.J.; A.P. Adelowo and F.O. Solagbade (2000). Design of a corn sheller. An unpublished B. Tech project LAUTECH, Ogbomoso, Nigeria.
- Alonge, A.F. and T.A. (2000). Adegbulugbe, Performance evaluation of a locally - developed grain thresher – II, *J Agr Mech Asia Africa Latin Am (AMA)* **31** (2): 52–54.
- AOAC (1970) Official methods of analysis 4th Ed. Association of Official Agricultural Chemists. Washington, D.C.
- Drik, E.M. (1996). Ear corn drying, storage and handling. Grain quality Task Force, Purdue Univ. is an equal opportunity/equal access institution. 1-3.
- Gore, K.L.; C.P. Gupta and C. Singh (1990). Development of power operated groundnut sheller. *AMA*, 21 (3): 38-44.
- Inglet, G.E. (1970). Corn culture: processing products, major feed and food crops, Agriculture and food series, AVI, Westport, CT, USA0.
- Ismail, Z.E. (1988). Evaluation of some parameter affecting corn thresher performance. *Misr. J. Ag. Eng.*, 5 (3) : 393 - 404.
- Kravchenko, V.S. and V.V. Kuceev (1979). Razrushenie pochatkov kukuruzy pri obmolote. [Destruction of maize ears by threshing.]. *Mehanizacija i Elektrifikacija Socialisticheskogo Seljskogo Khozjajstva*, 2, 44–45.
- Nimfa, D.m. and C.R. Alexis (2009). Fulfilling the farmers' corn shelling needs: the uplb corn sheller (A technology and market development study). *Cem Wrking Paper Series No. 2009-19* College of Economics and Management Univ. of the Philippines Los Baños College, Laguna Philippines, 1-15
- Nkokini, S.O.; M.J. Ayotamuno and G.P.D. Maeba (2007). Manually-powered continuous-flow maize-sheller. *Vol. 84* (12): 1175-1186.
- Petkevichius, S.; L. Shpokas and H.D. Kutzbach (2008). Investigation of the maize ear threshing process. *Biosystems engineering* 99, 532–539.
- Sudajan, S.; V.M. Salokhe and K. Tritatanasirichai (2002). Effect of type of drum, drum speed and feed rate on sunflower threshing. *Biosystem Engineering*, 83 (4): 413-421.
- Vindizhev, N.L. and V.V. Blaev (1983). Povrezhdaemostj semjan kukuruzy raznyh gibridov pri obmolote i puti ee snizhenija. [Damage of maize grains different crossbreeds by threshing and ways for their reduction.]. *Materialy nauchnoj-prakticheskoy konferencii "Molodezhj, nauka, tehnika"*. *Naljchik*, 187–190.

وحدة تفريط ذرة ترددية من نوع البديل اليدوي

عصام حسنى الحنفى

معهد الكفاية الإنتاجية – جامعة الزقازيق

يعتبر الذرة من المحاصيل الهامة في العالم وخصوصاً مصر لما له من أهمية كبيرة كغذاء رئيسي لكافة الشعب على مدار السنة، كما أنه يدخل كعنصر أساسى في تكوين علائق الغذاء الحيوانى والداجنى. ويتم إنتاج محصول الذرة موسمياً في حين يكون الإستهلاك على مدار العام مع الوضع في الاعتبار أن معظم المزارعين يمتلكون حيازات صغيرة مما يجعلهم يلجأون إلى تفريط كيزان الذرة يدوياً وهي عملية شاقة ومؤلمة ومكلفة وذات إنتاجية بسيطة كما أن غالبية آلات التفريط المتوفرة في السوق تعتمد على الدرافيل في عملية التفريط وهي آلات ينتج عنها نسبة تلف وكسر كبيرة نسبياً للحبوب نتيجة للصدمات التي تتعرض لها الحبوب أثناء عملية التفريط.

لذلك كان الهدف من هذا البحث تصميم وتصنيع وتقييم آلة تفريط ترددية تعمل يدوياً يسهل تشغيلها وصيانتها وذات كفاءة تفريط عالية وإنتاجية مقبولة في وقت مناسب مع تقليل نسبة تلف وكسر الحبوب إلى أقل ما يمكن. تمت دراسة صفات كيزان الذرة، صنف هجين ثلاثى 324 عند رطوبة 10.8% للحبوب و10.3% للقوالب على أساس رطب وذلك لوضع تصميم لنموذج التفريط الترددي الذي يعمل يدوياً والذي تم تنفيذه بقسم الهندسة الزراعية جامعة المنصورة، ويتكون النموذج المصمم من ماسك الكيزان وهو عبارة عن ثلاث وحدات متشابهة كل وحدة عبارة عن أنبوب مخروطي مفتوح من ناحية لوح التفريط، وضعت أبعاد الأنابيب بعد دراسة الصفات الطبيعية لكيزان الذرة. ولوح تفريط ترددي يأخذ حركته من كرنك يدار بواسطة يد حيث تنتقل الحركة من اليد إلى الكرنك ومنه إلى زراع توصيل يقوم بتحويل الحركة الدورانية إلى حركة ترددية على لوح التفريط المزود بأسنان تقوم بعملية التفريط. ولتحقيق هذا الهدف تم دراسة العوامل التصميمية المؤثرة على كفاءة التفريط ونسبة الكسر والإنتاجية كالآتي:

- 1 - ثلاث مستويات لعدد الأسنان على لوح التفريط بالنسبة للمساحة
- 2 - ثلاث أزمنة لتردد لوح التفريط ثانية/تردد.
- 3 - أربع مستويات لنصف قطر الكرنك.
- 4 - ثلاث سرعات ترددية للوح التفريط.
- 5 - ثلاث مستويات للخلوص بين لوح التفريط وماسك الكيزان.

وكانت أهم النتائج المتحصل عليها:

- 1 - أنسب عدد لأسنان التفريط على لوح التفريط هو 100 سنة وتوصى الدراسة بهذا العدد للحصول على أفضل كفاءة تفريط.
- 2 - تزيد كفاءة التفريط والإنتاجية مع تقليل زمن التردد وكانت أفضل النتائج في مدى 0.85 – 0.93 ثانية/تردد.
- 3 - أوضحت النتائج أن هناك علاقة واضحة بين نصف قطر عمود الكرنك وعدد ترددات لوح التفريط في الدقيقة والخلوص بين لوح التفريط وجهاز ماسك الكيزان حيث زادت كفاءة التفريط عند زيادة نصف قطر الكرنك وعدد الترددات مع أقل خلوص.
- 4 - زادت كفاءة التفريط عند تقليل الخلوص في جميع المعاملات.
- 5 - أدت زيادة السرعة الترددية للوح التفريط في المدى من 11-13 متر/ثانية إلى زيادة واضحة في كفاءة التفريط في جميع المعاملات.
- 6 - كانت أفضل كفاءة تفريط 98.8% وأقل نسبة عدم تفريط 1.2% عند نصف قطر 10.5 سم وزمن التردد الواحد 0.93 ثانية/تردد وعدد ترددات لوح التفريط 64 تردد/دقيقة وخلوص 25 مم من لوح التفريط وماسك الكيزان مع عدد 100 سنة على لوح التفريط.
- 7 - كانت أعلى إنتاجية لنموذج التفريط عند نفس المعاملات السابقة.
- 8 - الحبوب الناتجة من نموذج التفريط صالحة لأغراض الطحن والزراعة حيث أن نسبة كسر وتلف الحبوب كانت أقل ما يمكن ويمكن إهمالها عند كل المعاملات.

قام بتحكيم البحث

أ.د / حسنى الشبراوى المرسي

أ.د / جمال الدين محمد نصر

كلية الزراعة – جامعة المنصورة

كلية الزراعة – جامعة القاهرة

