

# Qualitative and Quantitative Evaluation for Auxiliary Feed Water System at Pressurized Water Reactor (PWR)

## التقييم الكمي والرقمي لنظام تغذية المياه الإضافي في مفاعلات الماء المضغوط

Mohamed Ahmed Elbaz, Prof. Dr/ Ahmed Sultan\* and Dr/ Tarek Nagla\*\*

\*Mansoura university Mechanical power department

\*\* Nuclear power plants authority

### ملخص

تتطلب محطات القوى النووية والصناعة النووية وكذلك صناعة الفضاء مستوي عالي جدا من الأمان لذلك من الضروري عمل تقييم للمخاطر لهذه المنظومات كاملة و الأنظمة الفرعية التي بها و مكونات تلك الأنظمة. لذلك يجب أخذ في الاعتبار بيانات معدل انهيار المكونات و احتمالات حدوثها، و عمل تقييم كمي و رقمي لحساب الإتاحة لهذه الأنظمة و ذلك باستخدام شجرة تحليل الأخطاء لنظام تغذية مياه الإضافي الذي يمد مولد البخار بالمياه أثناء حادثة فقد نظام تغذية المياه الرئيسي أو انقطاع الطاقة الكهربائية عن نظام تغذية المياه الإضافي. حيث هناك نظامين متوازيين منفصلين لمولد البخار الواحد كل نظام له قدرة تصل إلي 100% .

توضح النتائج التقييم الكمي لنظام تغذية المياه الإضافي و كذلك التقييم الرقمي للنظام وذلك باستخدام بيانات معدل انهيار المكونات، كما توضح الدراسة عدم الإتاحة لكل عنصر في النظام و كذلك عدم إتاحة النظام ككل علي مدار 8760 ساعة. ليتم التأكد من إتاحة النظام علي مدار العام ، ونوصي بإجراء دورات الاختبارات و الصيانة في الموعد المحدد لها تماما.

### Abstract

Nuclear power plant, nuclear industry and aerospace industry require a high level of safety so it is necessary to make risk assessment for these systems, subsystems and components. So, it is needed to take into consideration the components failure rate and its probability, and have qualitative and quantitative evaluation using fault tree analysis. The conducted study is aiming to make qualitative and quantitative evaluation for Auxiliary Feed Water system (AFWS) which is designed to supply feed water to the steam generators for Reactor Coolant System (RCS) heat removal in a case of loss of main feed water or loss of all AC (alternating current) power to the station auxiliary, (AFWS) consisted of two trains to single steam generator which achieve 100% capacity for each train, Complete redundancy and diversity achieved.

Results show the qualitative evaluation of auxiliary feed water system, this qualitative assessment is supported by failure rate data of components to have quantitative evaluation, this study indicated the unavailability of the individual components and the total unavailability of the (AFWS) for 8760 hour. To be sure that the system is available during operation periods, test and repair periods must be obtain at its exact scheduled time.

### Nomenclature

|              |   |                      |   |
|--------------|---|----------------------|---|
| <b>A</b>     | Availability                                | <b>MTTF</b>          | mean time to fail                       |
| <b>AC</b>    | Alternating current                         | <b>N</b>             | Number of items                         |
| <b>AFWS</b>  | Auxiliary feed water system                 | <b>N<sub>F</sub></b> | Number of failures                      |
| <b>CSS</b>   | Containment spray system                    | <b>q</b>             | Unavailability                          |
| <b>F</b>     | Unreliability                               | <b>R</b>             | Reliability                             |
| <b>IRWST</b> | In-containment refueling water storage tank | <b>RCS</b>           | Reactor coolant system                  |
| <b>LOCA</b>  | Loss of coolant accident                    | <b>SIS</b>           | safety injection system                 |
| <b>MDT</b>   | Mean down time                              | <b>t</b>             | Time                                    |
| <b>MTBF</b>  | Mean time between failure                   | <b>U</b>             | T <sub>D</sub> Down time Unavailability |
|              |   | <b>λ</b>             | Failure rate                            |

# 1 Introduction

## 1.1 Description of (PWR)

Nuclear power plants play an important role in facing the increasing demand of electrical power. For a nuclear power plant to perform the function of generating electricity, many different systems must perform their functions. These functions may range from the monitoring of a plant parameter to the controlling of the main turbine or the reactor.

There are two major systems utilized to convert the heat generated from fuel into electrical power for industrial and residential use. The primary system transfers the heat from the fuel to the steam generator, where the secondary system

begins. The steam formed in the steam generator is transferred by the secondary system to the main turbine generator, where it is converted into electricity. After passing through the low pressure turbine, the steam is routed to the main condenser. Cool water, flowing through the tubes in the condenser, removes excess heat from the steam, which allows the steam to condense. The water is then pumped back to the steam generator for reuse.

In order for the primary and secondary systems to perform their functions, there are approximately one hundred support systems. In addition, for emergencies, there are dedicated systems to mitigate the consequences of accidents, see figure 1. [1]

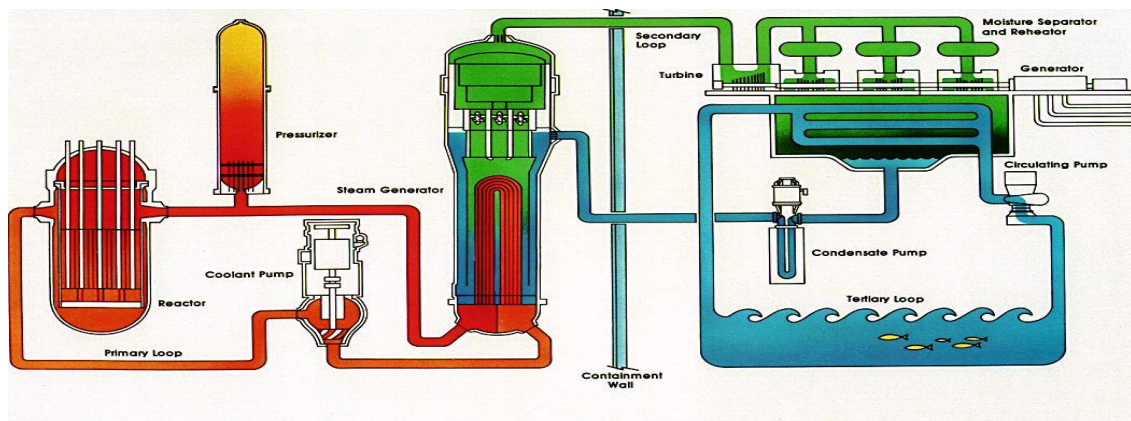

Figure 1 indicates primary loop and secondary loop

## 1.2 safety systems

The safety systems consist of the safety injection system (SIS), the in-containment refueling water storage tank (IRWST), the containment spray system (CSS), and the auxiliary feed water system (AFWS) which is located at auxiliary building, see figure 2.

The AFWS is designed to supply feed water to the SGs for reactor coolant system RCS heat removal in a case of loss of main feed water. In addition, the AFWS refills the SGs following a LOCA to

minimize leakage through pre-existing tube leaks, see figure 3. [2]

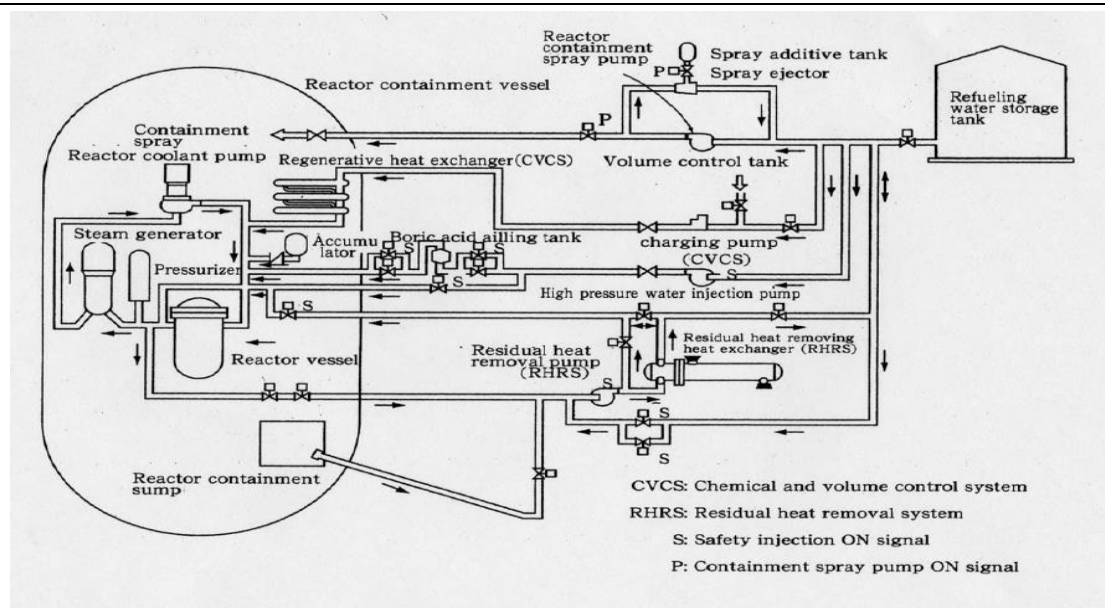

Figure 2. Safety systems in nuclear power plant

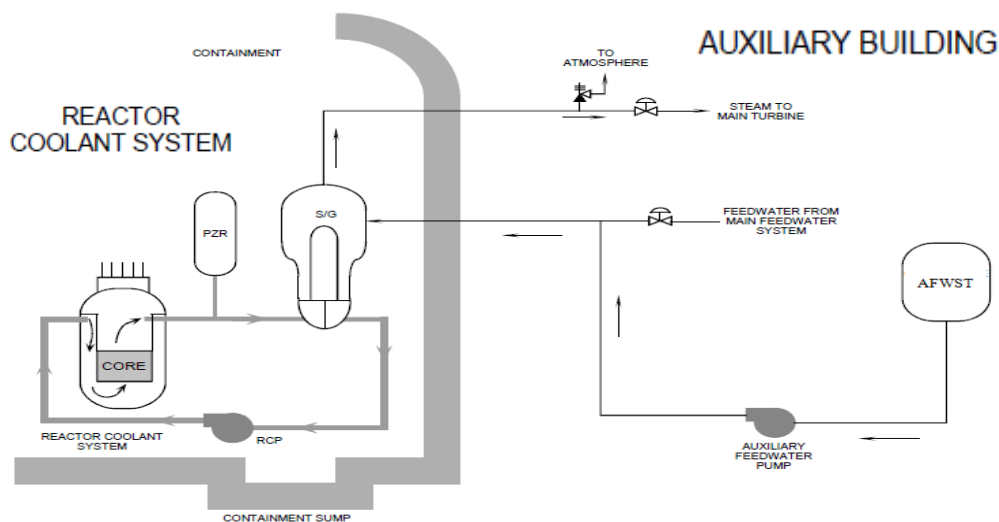

Figure 3. Auxiliary feed water system and its connection to steam generator

## 2 Auxiliary Feed Water System (AFWS)

The auxiliary feed water system is designed to supply high-pressure feed water to the steam generators in order to maintain a water inventory for removal of heat energy from the reactor coolant system by secondary side steam release in the event of inoperability or unavailability of the main feed water system and loss of all AC power to the station auxiliary.

Redundant supplies are provided by two pumping systems using different sources of power for the pumps. The design capacity of each system is set so that the steam generators will not boil dry nor will the primary side relieve fluid through the pressurizer relief valves, following a loss of main feed water flow with a reactor trip, See Figure 4.

The AFWS is a system of two divisions and four trains which supply water to two steam generator (2 trains to

steam generator). The reliability of the AFWS is increased through the use of two motor-driven pumps, two turbine-driven pumps, and two independent safety-related emergency feed water storage tanks located in the auxiliary building (AFWST). It consists of two trains to single steam generator which achieve 100% capacity for each train. Complete redundancy and diversity achieved, where division 1 is parallel with division 2, there is only orifice which series with the two parallel divisions.

Major Components per each SG.

- Turbine driven pump 100% capacity.
- Two check valve.
- Solenoid Globe valve which is normally open.
- DC motor gate valve which is normally open.
- Motor driven pump 100% capacity.

The auxiliary feed water system has no functional requirements during normal plant operation. It is used during plant startup and shutdown and during hot shutdown or hot standby conditions when chemical additions or small feed water flow requirements do not warrant the operation of the main feed water and condensate systems. During normal plant operations, the auxiliary feed water system is maintained in a standby condition ready to be placed in operation automatically when conditions require. [3] & [4]

### 3 Reliability & availability

Reliability (R) is a characteristic of design. It is defined as the 'probability that a specified item will perform a specified function within a defined environment, for a specified length of time'. For complex systems the reliability requirement is normally specified in terms of the mean time between failures (MTBF) or as a failure rate, for example failures per million operating hours. The unreliability (F) of item can be defined as the 'probability of that item may fail to perform its function, for a specified length of time'. Both reliability and unreliability vary with time. Reliability  $R(t)$  decreases with time: an item that has been just tested and shown to meet specification has reliability value of 1 when first placed in service, one year later this may decrease to 0.5. Unreliability  $F(t)$  increases with time; an item that has been just tested and shown to meet specification has unreliability value of 0 when first placed in service, one year later this may increase to 0.5. So the sum of reliability and unreliability must be 1. see figure 5.

$$R(t) = e^{-\lambda t}$$

$$R(t) + F(t) = 1$$

$$F(t) = 1 - R(t)$$

Where:

$\lambda$ =failure rate

t= time

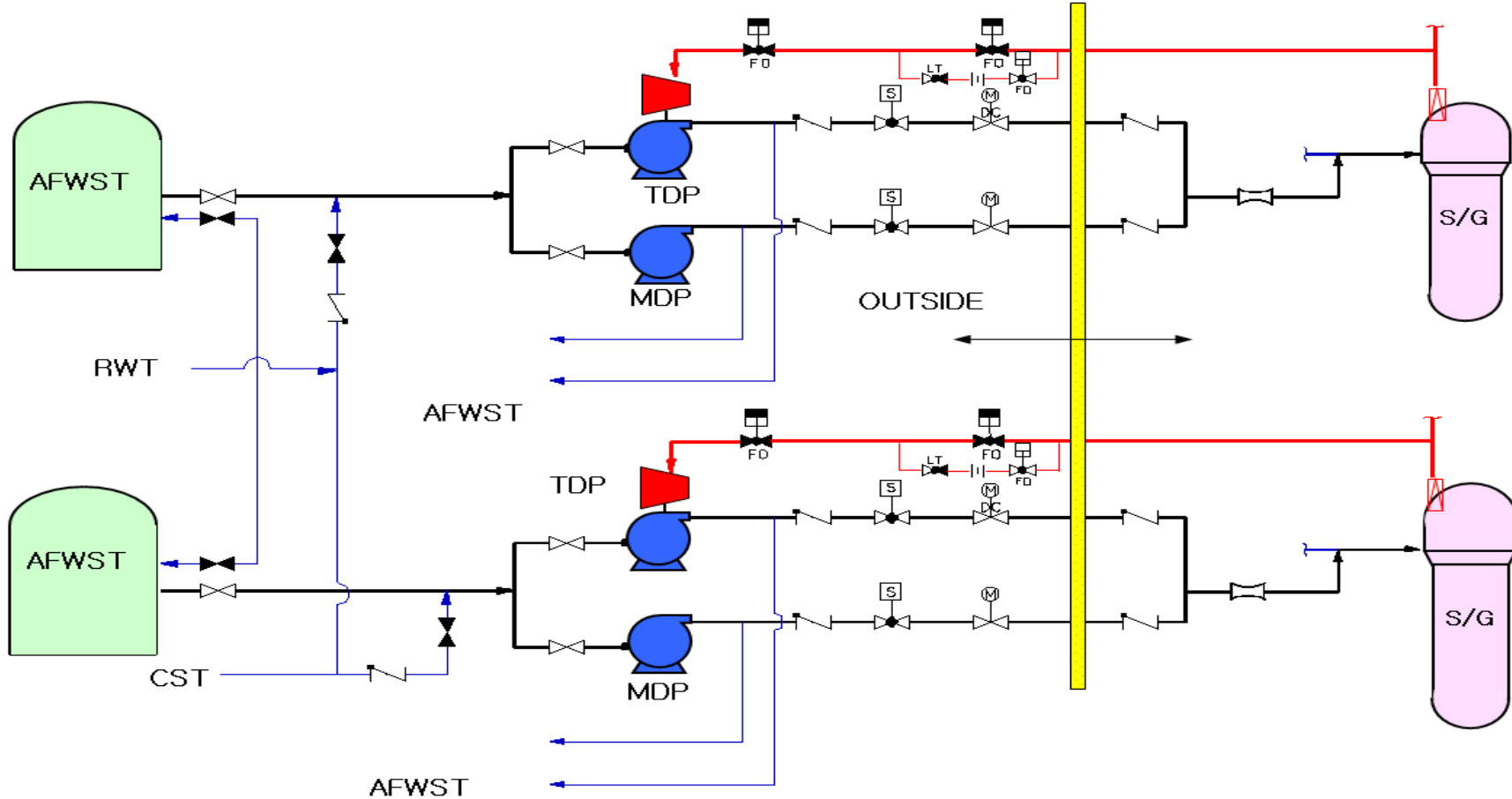

Figure4. Auxiliary feed water system (AFWS)

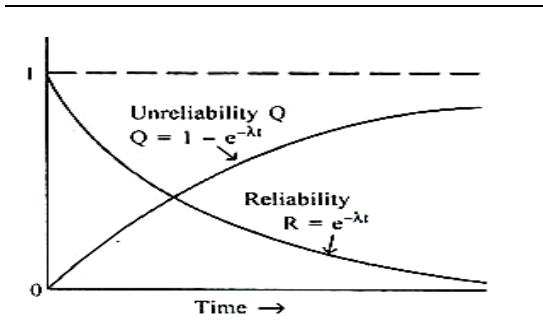

Figure 5. Reliability and unreliability with constant failure model.

The behavior of failure rates with time is quite revealing the failure rate curve usually has the general characteristics of a "bathtub" as shown in Figure 6.

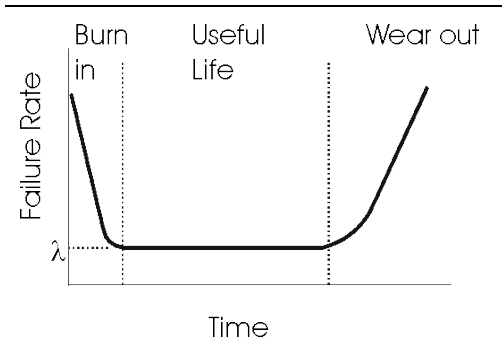

Figure6. Typical variation in instantaneous failure rate (hazard rate) during life time of product "bathtub curve".

Figure 4 shows the most general form of failure rate  $\lambda(t)$  of product through the life time. Bathtub curve consists of three regions; burn in, useful life and wear out failure. The burn in early failure region where  $\lambda(t)$  decreasing with time. When items are new, especially if product is new design, early failure can occur due to design fault, poor quality component, manufacturing fault, installation error, and operating and maintenance error. The useful life region is characterized by a low constant failure rate. Here all components have been removed; design, manufacturing, installation, operating and maintenance error rectified so the failure is due to unpredictable cause. The wear out region is characterized by  $\lambda(t)$  increasing

with time as individual item approach end of design life for product, long life time of the component which make up the product are now wear out.

### 3.1 Non-repairable items

Suppose that N individual items of given non-repairable product are placed in service and the times at which failure occur are recorded during test interval T. Assuming that N item fail during T and ith failure occurs at time  $T_i$ , which is  $T_i$  is survival time or UP time for the ith failure as shown in figure 7. The total up time for N failures is therefore

$$\sum_{i=1}^{i=N} T_i$$

And mean time to failure is given

by: mean time to fail =  $\frac{\text{Total up time}}{\text{Number of failure}}$

$$MTTF = \frac{1}{N} \sum_{i=1}^{i=N} T_i$$

$$\bar{\lambda} = \frac{N}{\sum_{i=1}^{i=N} T_i}$$

Mean failure rate is reciprocal of MTTF. MTTF is the total area under graph.

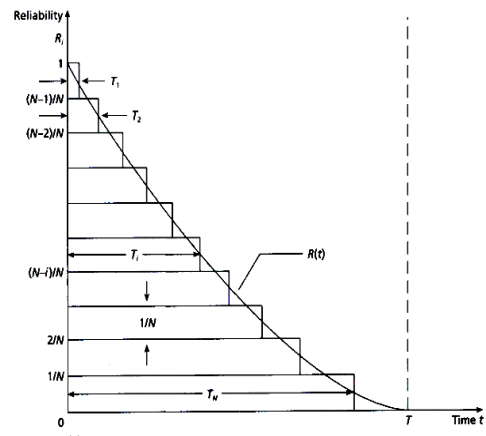

Figure7. Failure rate of non-repairable items.

$$MTTF = \int_0^{\infty} R(t) dt$$

### 3.2 Repairable items

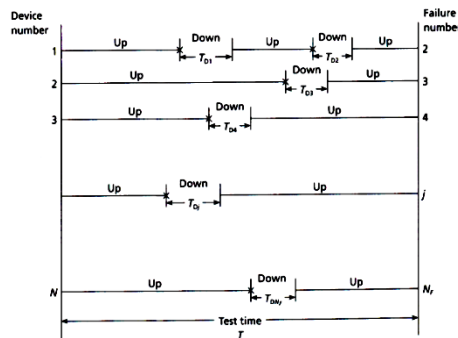

Figure 8. Failure rate of repairable items.

Figure 8 shows the failure pattern for N repairable items observed over attest interval T. The down time  $T_{Dj}$  associated with  $j$ th failure is the total time between elapses between the occurrence of the failure and the repair item to be back into normal operation. The total down time of  $N_f$  failures is therefore  $\sum_{j=1}^{N_f} T_{Dj}$  and the mean down time is given by:

$$\text{mean down time} = \frac{\text{Total down time}}{\text{Number of failure}}$$

$$MDT = \frac{1}{N_F} \sum_{j=1}^{j=N_F} T_{Dj}$$

$$\text{Total up time} = NT - \sum_{j=1}^{j=N_F} T_{Dj}$$

$$= NT - N_F MDT$$

$$\begin{aligned} \text{mean time between failure} \\ = \frac{\text{Total up time}}{\text{Number of failure}} \end{aligned}$$

$$MTBF = \frac{NT - N_F * MDT}{N_F}$$

$$\text{mean failure rate} = \frac{\text{Number of failure}}{\text{Total up time}}$$

$$\bar{\lambda} = \frac{N_F}{NT - N_F * MDT}$$

Availability of an item/system is the probability that this item/system will be in a state to perform a required function under given conditions, at a given instant in time or over a time interval, assuming

that the given external resources are provided. [5]

$$A = \frac{UP\ TIME}{TOTAL\ TIME}$$

$$A = \frac{UP\ TIME}{UP\ TIME + DOWN\ TIME}$$

$$A = \frac{MTBF}{MTBF + MDT}$$

So the availability depends on MTBF, that is availability depends on reliability. Availability can be increased by increasing MTBF, reducing the mean failure rate. Also it depends on MDT mean down time, availability increases by decreasing MDT, how quickly the product is repaired and put back into service.

### 4 Analysis of Auxiliary Feed Water System by using fault tree

A fault tree analysis can be simply described as an analytical technique, whereby an undesired state of the system is specified (usually a state that is critical from a safety standpoint), and the system is then analyzed in the context of its environment and operation to find all credible ways in which the undesired event can occur. The fault tree itself is a graphic model of the various parallel and sequential combinations of faults that will result in the occurrence of the predefined undesired event. The faults can be events that are associated with component hardware failures, human errors, or any other pertinent events which can lead to the undesired event. A fault tree thus depicts the logical interrelationships of basic events that lead to the undesired event-which is the top event of the fault tree.

It is also important to point out that a fault tree is not in itself a quantitative model. It is a qualitative model that can be evaluated quantitatively and often is. This qualitative aspect, of course, is true of virtually all varieties of system models. The fact that a fault tree is a particularly



convenient model to quantify does not change the qualitative nature of the model itself. [6]

The construction of the fault tree necessitates a thorough understanding of the system. The undesired event, called the "top event" must be carefully defined. Furthermore, the limit of resolution should be stated, potential system interfaces identified and constraints of the analysis realized.





The primary failure, which is the failure of a component in an environment for which it is qualified. A secondary failure is the failure of a component in an environment for which it is *not* qualified.

In other words, the component fails in a situation which exceeds the conditions for which it was designed. [7]

Auxiliary feed water system is located at auxiliary building in nuclear power plant, this means that high quality at manufacturing, installing of components. So secondary failure of components will be neglected. It is assumed that (AFWS) will operate nearly one month during a year 720 hr, and the eleven months is in standby mode. All input data will be in table 1. [8] & [9]

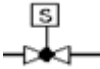
Complete qualitative fault tree of (AFWS) is shown in figure 9.

*Table 1 indicates all input data of operating and standby failure rate, test interval, operation time and repair time.*

| component           | symbol  | Operating failure Rate $\lambda_0$ | Standby failure Rate $\lambda_s$ | Test interval (hr) | Time of operation (hr) | Time of repair (hr) |
|---------------------|---|------------------------------------|----------------------------------|--------------------|------------------------|---------------------|
| Turbine Driven pump |  | 5.70E-05                           | 1.00E-08                         | 240.0              | 720.0                  | 24.5                |
| Globe valve         |  | 3.50E-06                           | 1.00E-08                         | 240.0              | 720.0                  | 1.7                 |
| Gate valve          |  | 3.00E-07                           | 1.00E-08                         | 240.0              | 720.0                  | 3.3                 |
| Check valve         |  | 2.00E-07                           | 1.00E-08                         | 8760.0             | 720.0                  | 1.7                 |
| Orifice             |  | 6.00E-07                           | 1.00E-08                         | 8760.0             | 720.0                  | 1.5                 |
| Motor Driven pump   |  | 5.60E-05                           | 1.00E-08                         | 240.0              | 720.0                  | 19                  |



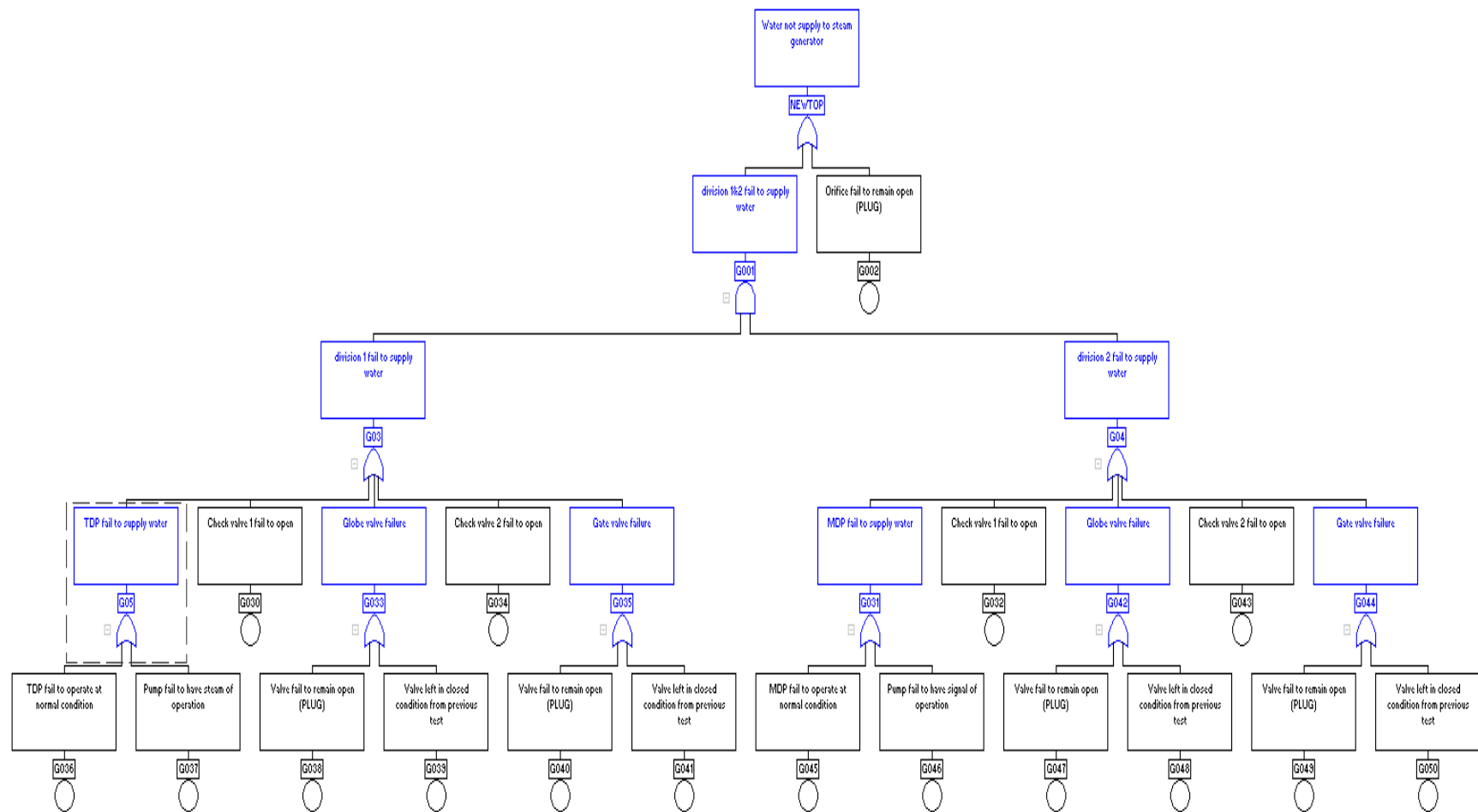
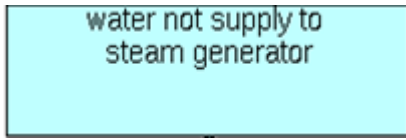

Figure9. Complete qualitative fault tree of (AFWS)

The function of (AFWS) is to deliver water to steam generator so the failure of supplying water is the undesired event (Top event).  
The undesired event (AFWS) is



In order not to supply water there are two probabilities if any of them occurs it will lead to top event so we will use OR GATE. First one that orifice failure to remain open (plug) OR train1 and train2 not supply water. Figure10.

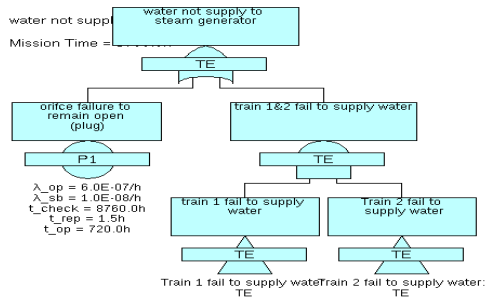

Figure 10. Fault tree construction.

Second probability that train1 and 2 fail to supply water to steam generator. See figure 11.

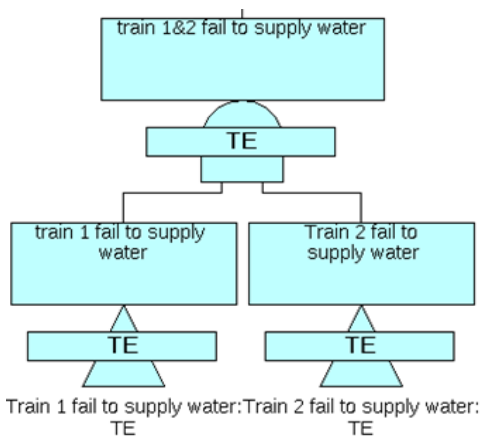

Figure 11 train1&2 fail to supply water.

For train 1 there are five probabilities if any one of them occurs leads to failure of train one will analyze by OR GATE. Failure of turbine driven pump or, globe valve or, gate valve or, any of check valves lead to failure of total system, See figure12.

Analysis of train 2 is the same for train 1 expect that turbine driven pump is placed by motor driven pump, See figure13.

The failure of turbine driven pump due to (TDP) is fail to operate at normal condition, or fail to have steam that operate turbine, see figure14.

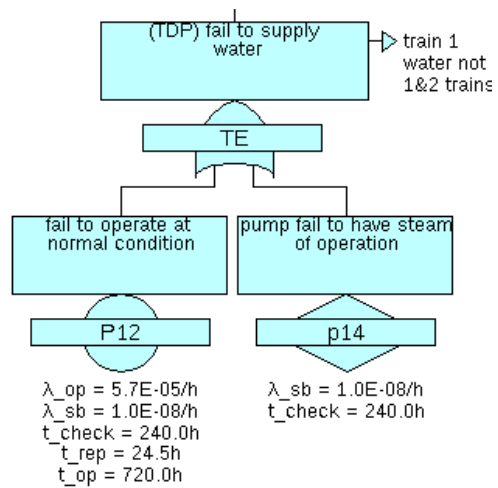

Figure14. TDP failure.

The failure of globe valve due to valve fail to remain open (plug) at normal condition, or valve left in closed condition from last test, see figure 15.

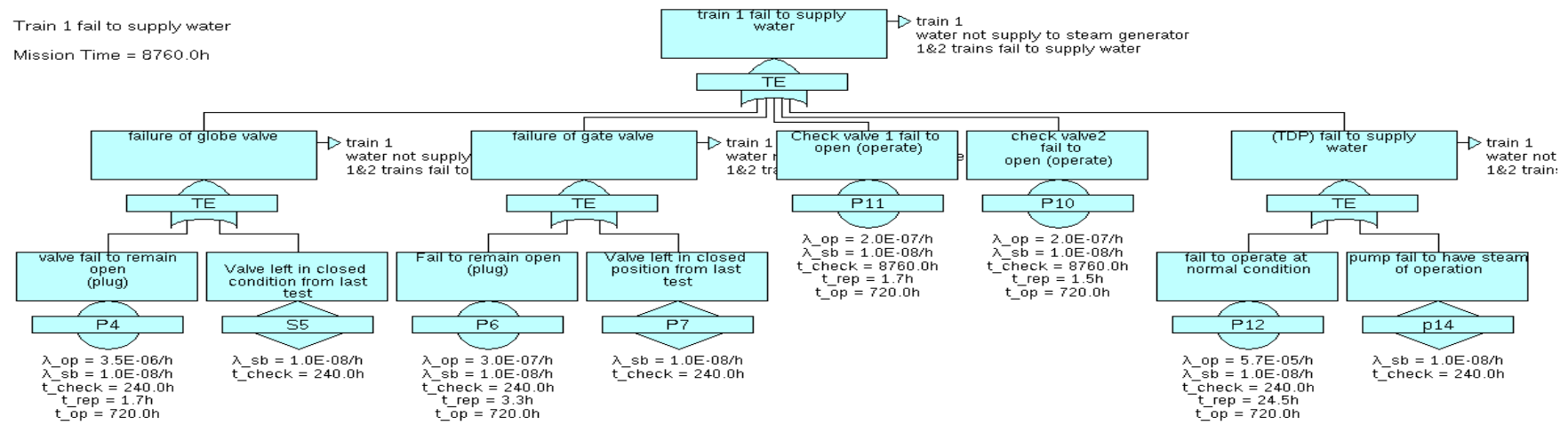

Figure12. The fault tree of train or system 1

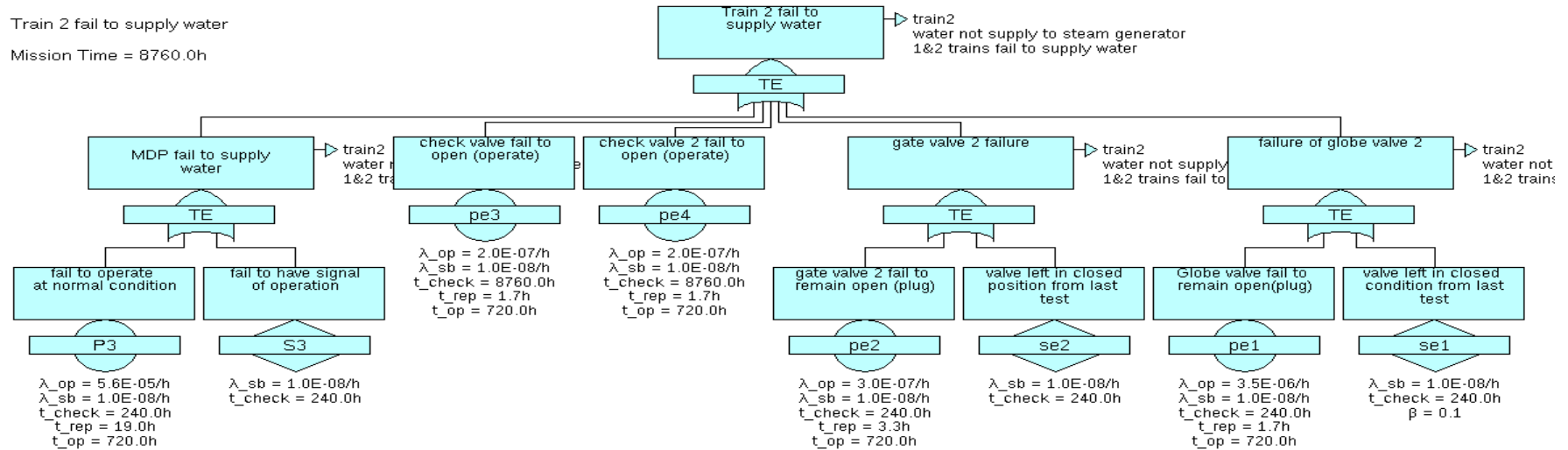

Figure13. The fault tree of train or system 2

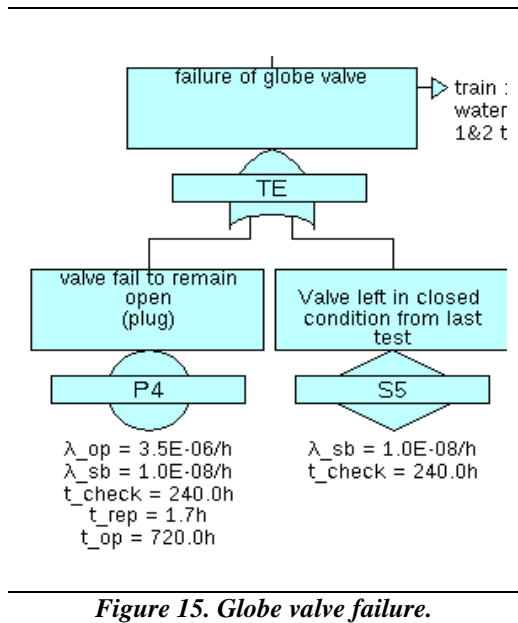

Figure 15. Globe valve failure.

The failure of gate valve due to valve fail to remain open (plug) at normal condition, or valve left in closed condition from last test, see figure 16.

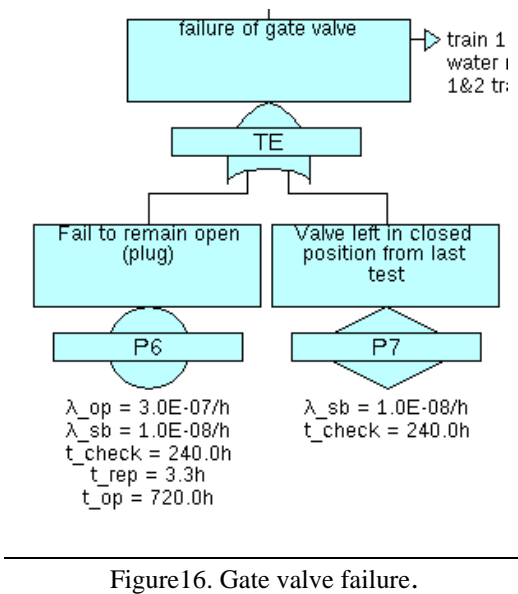

Figure16. Gate valve failure.

The failure of first and second check valve due to check valve fail to open, see figure17. [10]

### 5 Results

At this point, first, a qualitative assessment of results and then, armed with some data, a gross quantitative assessment can be made. Qualitatively, the leading contributor to the top event is the failure of

the orifice or the failure of the both parallel system. The failure of division 1 is due to failure of turbine driven pump, or failure of globe valve, or failure of gate valve, or failure of check valves. The same thing for division 2 the failure of division 2 is due to failure of motor driven pump, or failure of globe valve ...etc.

To make quantitative evaluation of unavailability for (AFWS) it is required to estimates the unavailability of each component. Table 2 provides values of q for components in system.

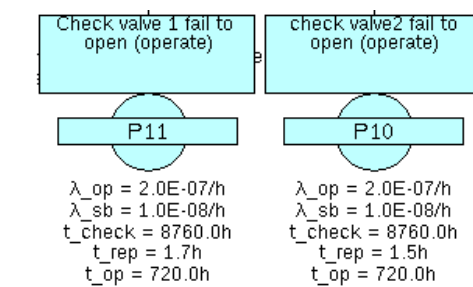

Figure17. Check valves failure.

Table 2 indicates all unavailability of components.

| Symbol | component           | Unavailability        |
|--------|---------------------|-----------------------|
|        | Turbine driven pump | $4.1 \times 10^{-2}$  |
|        | Globe valve         | $2.52 \times 10^{-3}$ |
|        | Gate valve          | $2.1 \times 10^{-4}$  |
|        | Check valve         | $1.88 \times 10^{-4}$ |
|        | Orifice             | $4.76 \times 10^{-4}$ |
|        | Motor driven pump   | $4.04 \times 10^{-2}$ |

The unavailability of division 1 is  $4.4 \times 10^{-2}$  and unavailability of division 2 is  $4.33 \times 10^{-2}$ , the unavailability of system 1

and 2 is  $1.9 \times 10^{-3}$ . The unavailability of (AFWS) equal  $2.38 \times 10^{-3}$ , so the availability of auxiliary feed water system (AFWS) is 0.9977 during a year this number is acceptable.

## 6 Recommendations

Quality assurance and quality control must be applied during the stages of, design, manufacturing, installation, operation and maintenance to be sure that all of system, subsystem and components have high reliability and to reduce its failure rate. To be sure that (AFWS) is available during operation period this requires Test and repair periods must be at exact schedule times.

## 6 References

- [1] *Reactor Concepts Manual*, United States Nuclear Regulatory Commission, Washington, 2001.
- [2] S. Lee & S Kim. *The Design Feature Of The Advanced Power Reactor 1400*, Korea Hydro& Nuclear Power, Seoul, 2009.
- [3] D. A. Casada, *Auxiliary Feed water System Aging Study*, United States Nuclear Regulatory Commission, Washington, 1990.
- [4] Ki-In Han, *Engineered safety features for APR1400*, KEPCO International Nuclear Graduated School, Seoul, 2014.
- [5] J.P. Bentley, *Introduction to Reliability & Quality Engineering*, Addison Wesley, Guisborough, 1998.
- [6] W. E. Vesely, F. F. Goldberg, N. H. Roberts, D. F. Haasl, *Fault Tree Handbook*, United States Nuclear Regulatory Commission, Washington, 1981.
- [7] M. Stamatelatos, J. Caraballo, *Fault Tree Handbook With Aerospace Application*, NASA, Washington, 2002.
- [8] *Reactor safety study*, United States Nuclear Regulatory Commission, Washington, 1975.
- [9] *Component Reliability Data For Use In Probabilistic Safety Assessment*, International Atomic Energy Agency, 1988.
- [10] T. Brunnengraber, *Functional safety suite 2.0.0*, Munich, Germany, 2012.