

## A modified Three-Phase AC-AC Boost Regulator with Unity Input Power Factor

**Osama M. Ali Salem**

Assistant researcher  
Mechanical & electrical research institute  
National water research Centre, Egypt  
Engosama\_87@yahoo.com

**Haitham Z. Azazi**

Department of electrical Engineering  
Faculty of engineering  
Menoufiya University, Egypt  
Haitham\_azazi@yahoo.com

**Azza E. Lashine**

Department of electrical Engineering  
Faculty of engineering  
Menoufiya University, Egypt  
Azzalashine@yahoo.com

### ABSTRACT

In this paper, a new configuration for high performance three-phase AC-AC boost regulator is presented. The proposed circuit has a high efficiency for adjusting AC power; because it has a fewer number of switches, and for this new configuration, a new control methodology is proposed to provide regulated AC output voltage. This new boost regulator provides, nearly unity input power factor, line current harmonics to be readily and economically filtered out. Also, harmonics of input current, load voltage and load current are almost negligible. The proposed method is implemented using a zero-crossing processing, which allows a greater accuracy than other methods. The developed modeling is experimentally verified, Measured, simulated and predicted waveforms using the proposed model are shown to be very close and the model is proved to be efficient and accurate.

يقدم هذا البحث مقترحاً حديثاً لتصميم منظم رافع للجهد ثلاثي الأوجه والذي يتمتع بكفاءة عالية وذلك لبساطة التكوين حيث أنه يحتوى على عدد قليل من المفاتيح المتحكم في كل من التيار والجهد ، إلى جانب بساطة تكوين الدائرة الأساسية (دائرة القوى) ، تم أيضا تكوين دائرة تحكم ذات منهجية جديدة للتحكم في قيمة الجهد والتيار. ويتميز هذا المنظم بتحسين معامل القدرة وتقليل قيمة التوافقيات في كل من الجهود والتيارات ، إضافة إلى ذلك يتمتع هذا المنظم بالإستمرارية في الأداء مهما تواجدت أى تشوهات في مصدر التغذية وتم تحقيق هذا المقترح معيلاً ومقارنة النتائج المعملية بالنظرية والتي أثبتت دقة وكفاءة النموذج المقترح.

**Key words :** AC-AC converter, AC boost regulator, power factor improvement, hysteresis control, zero-crossing detector.

### I. INTRODUCTION

AC voltage regulation is an important part of power conversion; AC regulators are widely used in applications requiring voltage regulation, reactive power compensation and power control [1]. These are also used in special motor drive systems such as self-starting induction motors and speed controllers for fans and pumps [2-4]. Most of the existing systems are conventional line commutated AC controllers with thyristor or triacs technology. Triacs or thyristor technology is usually employed as the power control elements of conventional AC-AC voltage controllers. The natural switching process of the thyristor device adversely affects the performance of conventional thyristor-controlled AC-AC voltage converters. However, the retardation of firing angle causes a lagging power factor at the input side, plentiful low-order harmonics in both output voltage and current and a discontinuity of power flow appears at both input and output sides [5- 6]. So solutions have been proposed to improve these defects such as adding a freewheeling path and this improves the input power factor slightly but cannot control the harmonics [7-11], also, these systems are suitable only for buck mode applications. A thyristor-controlled transformer booster has been suggested and examined [12], but such devices are of limited range and introduce distortion in the voltage

waveform. Saturable reactor voltage regulator with improved current waveform was obtained [13], but distortion was noticeable at low levels of output voltage. Different topologies and control techniques were proposed to realize unity power factor at the ac source side but large number of switches and sophisticated control techniques were required for the AC-DC-AC conversion system [14]. Recently, a family of PWM AC-AC power converters has been proposed which using gate turn-off switching devices like GTOs or IGBTs in its design [15-16].

The advantages to be gained include sinusoidal input-output current/ voltage waveforms, better input power factor and substantially smaller input/output filters, besides the wide and continuous range of control [17-18]. Although high input power factor has been achieved, these types of regulators were used in the buck mode only. Other techniques have been proposed for AC-AC regulation which based on electronic transformer [19], although electronic transformer gave higher efficiency and better voltage regulation, large number of switches and sophisticated control techniques were required. Another boost regulator technique was proposed which is similar to an electronic step-up coreless transformer, although it has nearly unity input power factor, it has nearly large number of switches and

diodes which make the circuit to be sophisticated [20].

In this paper, a new topology for high performance three-phase AC-AC boost regulator is proposed, and for this new topology, a new control methodology is proposed to provide regulated AC output voltage. The principle of operation and control of the regulator will be presented. The new boost regulator has nearly unity input power factor. Detailed analysis and modeling of the regulator in combination with static loads is presented and then the waveforms of voltage, current and their harmonics spectrum and power factor are discussed and verified in detail. The state equations, which describe the operation of the regulator, will be presented. Experimental and simulated results verifying the validity of the proposed analysis will be presented also.

## II. Proposed topology

### A. Power circuit

A three phase boost type voltage regulator is proposed as shown in Fig.1, in this approach, only four unidirectional switches are used and arranged as shown in the figure. The AC switches and the boost inductors are located between the AC source and the load, three delta-connected AC capacitors are located across the load terminals. The switches are arranged as follows ( $S_{aa}$ ,  $S_{bb}$ ,  $S_{cc}$ ) as a series switches (main switches) and the other switch ( $S_{abc}$ ) is connected in parallel with the source through a bridge rectifier. The series-connected switches regulate the power delivered to the load, and the parallel one provides a freewheeling path (short circuit) of both the source and the boost inductors ( $L_{Ba}$ ,  $L_{Bb}$ ,  $L_{Bc}$ ) when the main switches are turned-off. Although the circuit has four switches, it needs a simple control circuit to control the corresponding AC switches. Since, the AC switches of the proposed circuit has a simple control circuit, this will simplify the controller design greatly.

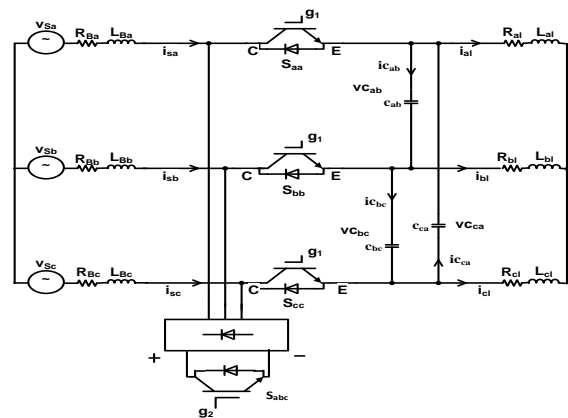

Fig.1 The proposed three-phase AC-AC boost voltage regulator

### B. Control strategy

Fig. 2 shows the block diagram of the control strategy, in the proposed regulator; only three independent hysteresis current controllers are used.

The voltage reference signal,  $v_{ref}$ , is set according to the required load voltage. This signal can be treated as a DC value which is proportional to the load phase voltage. Using a RMS value detector, the phase load voltage  $v_{al}$  is converted to a corresponding DC value. This value is compared with the reference voltage signal,  $v_{ref}$ , and the error signal is passed through a proportional integral controller. The output of the controller is then multiplied by the unit vector of the supply phase voltages  $v_{sa}$ ,  $v_{sb}$  and  $v_{sc}$  to produce the command currents  $i_{sac}$ ,  $i_{sbc}$  and  $i_{sc}$  respectively. These unit vectors are estimated by passing the input voltages through a zero-crossing detector, and the output of this detector is fed to sine wave look-up table which provide a rectified input voltage with unity amplitude.

The zero-crossing detector is used with the proposed control method in order to achieve a good performance under distorted supply voltage. While the supply voltage has a distortion waveform, the zero-crossing detector does not affected with the shape of supply voltage waveform, so a sine wave voltage waveform with unity amplitude can be achieved even a non-sinusoidal supply voltage waveform is used, so this approach has a simple control compared with other methods.

Then the supply currents  $i_{sa}$ ,  $i_{sb}$  and  $i_{sc}$  are compared with their corresponding commands,  $i_{sac}$ ,  $i_{sbc}$  and  $i_{sc}$  respectively, and the errors are processed through three independent hysteresis controllers. The

outputs of the hysteresis controllers are processed through three logic AND gates and compared with the outputs of the logic control signals which detect the higher value of the supply currents  $i_{sa}$ ,  $i_{sb}$  and  $i_{sc}$  then passed through a logic OR gate to produce the logic signals (pulses) for  $g_1$  and  $g_2$ . These logic signals will be used to control the four ac switches.

If the supply current is controlled to follow the current command, it follows the supply voltage in its waveform and follows the reference voltage in its magnitude. This is easily achieved, since the reference current is generated from and synchronized with the supply voltage. This control strategy ensures that the input power factor is almost kept at unity.

**C. Modes of operation**

Since the pulses of  $g_1$  are complementary of the pulses of  $g_2$ , the proposed boost regulator shown in Fig.1 has two modes of operations;

*Mode 1:  $S_{aa}, S_{bb}$  and  $S_{cc}$  ON and  $S_{abc}$  OFF:* In this mode the supply voltage is connected directly to the load, supply currents flow to the load through the boost inductors. At the same time, the  $\Delta$ -connected capacitors ( $c_{ab}$ ,  $c_{bc}$  and  $c_{ca}$ ) are charged. This mode continues until the supply currents  $i_{sa}$ ,  $i_{sb}$  and  $i_{sc}$  decrease less than or equal to  $\{(i_{sac}, i_{sbc}$  and  $i_{scc})-0.5 H\}$ , where H is the hysteresis band.

*Mode 2:  $S_{aa}, S_{bb}$  and  $S_{cc}$  OFF and  $S_{abc}$  ON:* In this mode, the control circuit allows the supply currents to increase. At the same time, the stored energy in capacitors discharges into the load. This mode continuous until the supply currents  $i_{sa}$ ,  $i_{sb}$  and  $i_{sc}$  increase to be more than or equal to  $\{(i_{sac}, i_{sbc}$  and  $i_{scc}) +0.5H\}$ .

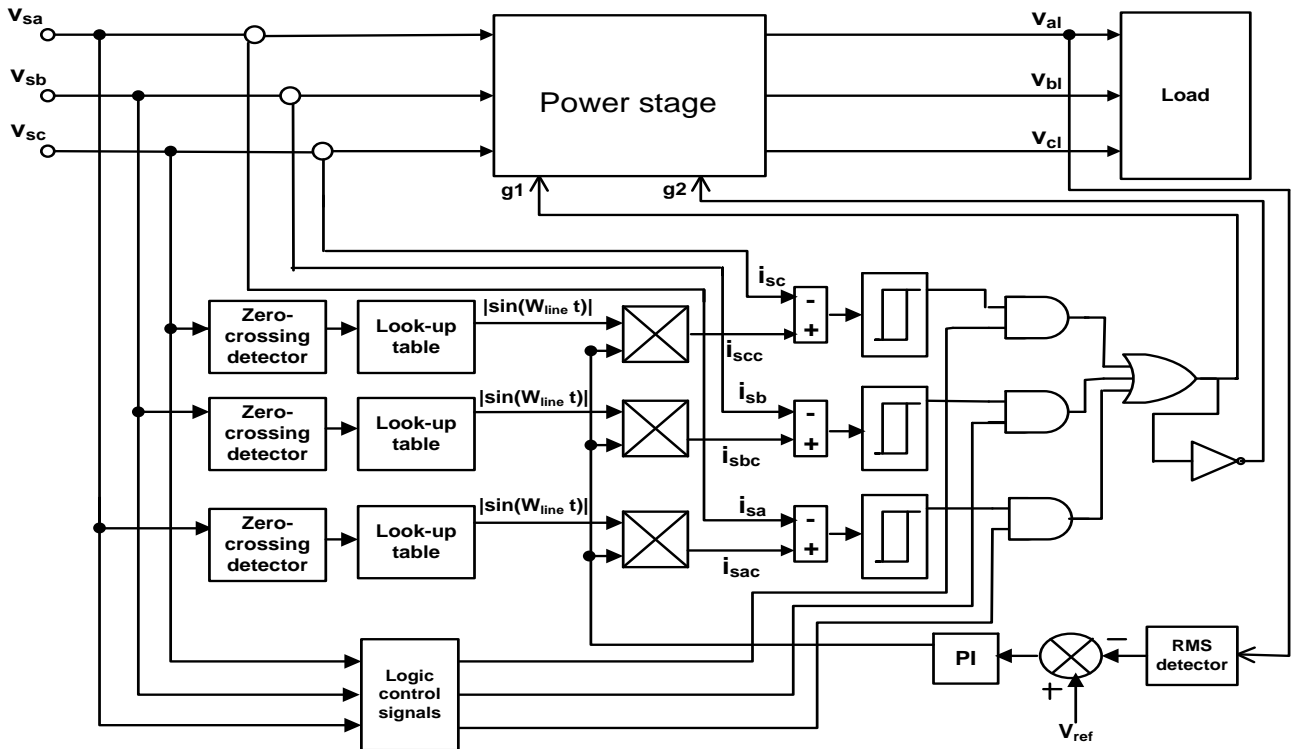

Fig.2 Block diagram of the proposed control strategy.

**III. Modeling and analysis**

For the two modes of operations the following equations could be deduced:

**Load equations:**

$$v_{c_{ca}} = i_{cl} R_{cl} + L_{cl} \frac{di_{cl}}{dt} - i_{al} R_{al} - L_{al} \frac{di_{al}}{dt} \tag{3}$$

$$i_{al} + i_{bl} + i_{cl} = 0 \tag{4}$$

**Capacitances equations:**

$$\Delta v_{c_{ab}} = \frac{1}{C_{ab}} \int i_{c_{ab}} dt \tag{5}$$

$$v_{c_{ab}} = i_{al} R_{al} + L_{al} \frac{di_{al}}{dt} - i_{bl} R_{bl} - L_{bl} \frac{di_{bl}}{dt} \tag{1}$$

$$v_{c_{bc}} = i_{bl} R_{bl} + L_{bl} \frac{di_{bl}}{dt} - i_{cl} R_{cl} - L_{cl} \frac{di_{cl}}{dt} \tag{2}$$

$$\Delta v_{c_{bc}} = \frac{1}{C_{bc}} \int i_{c_{bc}} dt \tag{6}$$

$$\Delta v_{c_{ca}} = \frac{1}{C_{ca}} \int i_{c_{ca}} dt \tag{7}$$

**Current equation:**  

$$i_{sa} + i_{sb} + i_{sc} = 0 \tag{8}$$

when  $S_{aa}$ ,  $S_{bb}$  and  $S_{cc}$  ON and  $S_{abc}$  OFF, the following equations could be derived:

$$v_{sa} - v_{sb} = i_{sa} R_{Ba} + L_{Ba} \frac{di_{sa}}{dt} + v_{c_{ab}} - i_{sb} R_{Bb} - L_{Bb} \frac{di_{sb}}{dt} \quad (9)$$

$$v_{sb} - v_{sc} = i_{sb} R_{Bb} + L_{Bb} \frac{di_{sb}}{dt} + v_{c_{bc}} - i_{sc} R_{Bc} - L_{Bc} \frac{di_{sc}}{dt} \quad (10)$$

$$v_{sc} - v_{sa} = i_{sc} R_{Bc} + L_{Bc} \frac{di_{sc}}{dt} + v_{c_{ca}} - i_{sa} R_{Ba} - L_{Ba} \frac{di_{sa}}{dt} \quad (11)$$

$$i_{sa} = i_{c_{ab}} + i_{a1} - i_{c_{ca}} \quad (12)$$

$$i_{sb} = i_{c_{bc}} + i_{b1} - i_{c_{cb}} \quad (13)$$

$$i_{sc} = i_{c_{ca}} + i_{c1} - i_{c_{bc}} \quad (14)$$

when  $S_{aa}$ ,  $S_{bb}$  and  $S_{cc}$  OFF and  $S_{abc}$  ON, the following equations could be derived:

$$v_{sa} - v_{sb} = i_{sa} R_{Ba} + L_{Ba} \frac{di_{sa}}{dt} - i_{sb} R_{Bb} - L_{Bb} \frac{di_{sb}}{dt} \quad (15)$$

$$v_{sb} - v_{sc} = i_{sb} R_{Bb} + L_{Bb} \frac{di_{sb}}{dt} - i_{sc} R_{Bc} - L_{Bc} \frac{di_{sc}}{dt} \quad (16)$$

$$v_{sc} - v_{sa} = i_{sc} R_{Bc} + L_{Bc} \frac{di_{sc}}{dt} - i_{sa} R_{Ba} - L_{Ba} \frac{di_{sa}}{dt} \quad (17)$$

$$i_{c_{ca}} = i_{c_{ab}} + i_{a1} \quad (18)$$

$$i_{c_{ab}} = i_{c_{bc}} + i_{b1} \quad (19)$$

$$i_{c_{bc}} = i_{c_{ca}} + i_{c1} \quad (20)$$

Equations from 1 to 14 cover mode 1, while Eqs. from 1 to 8 and Eqs. From 15 to 20 cover mode 2.

The rate of change of  $i_{sa}$ ,  $i_{sb}$  and  $i_{sc}$  is determined by the values of the input inductances  $L_{Ba}$ ,  $L_{Bb}$  and  $L_{Bc}$  and capacitors  $C_{ab}$ ,  $C_{bc}$ ,  $C_{ca}$  during mode 1, and by the values of  $L_{Ba}$ ,  $L_{Bb}$  and  $L_{Bc}$  during mode 2. Accordingly, the switching frequency is determined by these values depending on the hysteresis band,  $H$ . Assuming balanced three-phase supply and  $i_{sn}$  is the rms value of the n-th harmonic component of the supply current, the input distortion factor THD is defined as:

$$THD = \sqrt{\frac{\sum_{n=2}^{\infty} I_{sn}^2}{I_{s1}^2}} \quad (21)$$

where  $i_{s1}$  is the rms value of the fundamental component of the supply current. The input power factor is given by:

$$PF = \frac{\cos \phi_1}{\sqrt{1 + THD^2}} \quad (22)$$

where  $\phi_1$  is the angle between the fundamental component of the supply current and phase voltage.

Equations (1-20) are used to simulate the boost regulator by the help of Matlab/Simulink Toolbox. The Simulink /Toolbox use the metaphors of a block diagram to represent the system.

#### IV. Simulation Results

A three-phase boost-type voltage regulator with the proposed control strategy has been built and simulated using the MATLAB/SIMULNK software. Simulation is carried out to determine the characteristics of the proposed boost regulator. The circuit parameters of the prototype are listed in the Appendix. The supply voltage is kept constant at 220V per phase and the reference voltage is controlled to allow boosting of the output voltage.

Fig. 3 shows the steady-state results of the proposed regulator at reference voltage 250V. Fig. 3(a) shows the supply phase voltage ( $v_{sa}$ ) and the supply phase current ( $i_{sa}$ ). It is clear that the supply current follows the supply voltage in its wave shape with nearly unity power factor, also the proposed circuit provides a good smoothing for the input current, as a result, the harmonics of the input current is very low. The use of a new control methodology ensures balanced three-phase currents with low harmonics distortion as shown in Fig.3 (b) and Fig.3(c) respectively. Moreover, it is evident from Fig. 3(d) that the load voltage is almost equal the reference voltage having a pure sine wave. The phase load voltage and current are shown in Fig. 3(e) which shows the validity of the proposed circuit of introducing a good performance, also by comparing Fig. 3(e) with Fig. 3(a), it could be detecting the improving of the input power factor approximately near to unity. Fig. 3(f) shows the three phase load currents with a high quality performance. Fig. 3(g) shows that by using such type of this new control it could be conclude that the input current doesn't change even if there is any abnormal change in the supply voltage waveform such as distorted supply voltage.

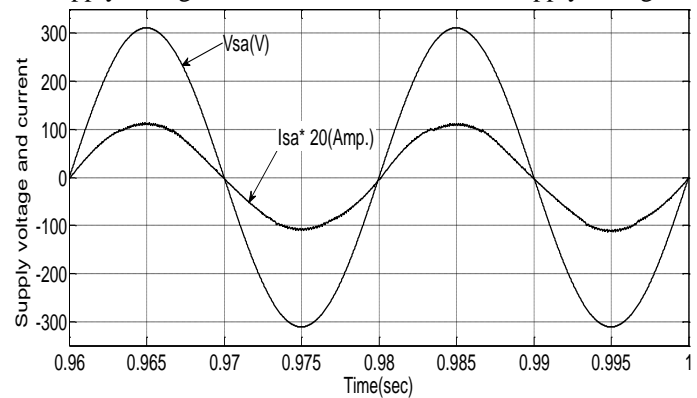

(a)

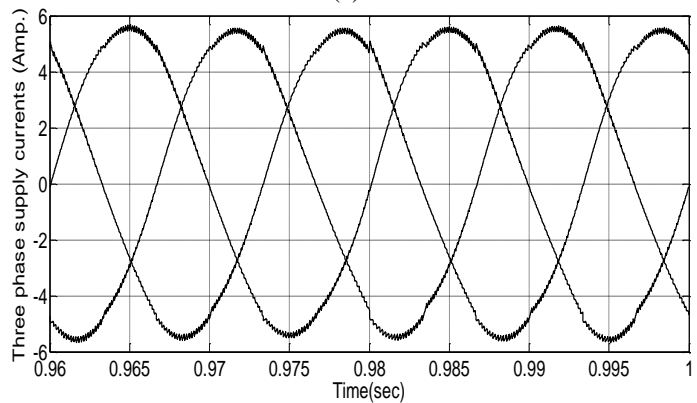

(b)

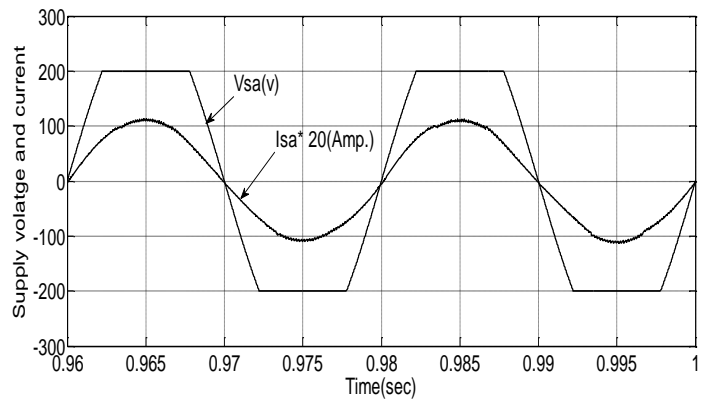
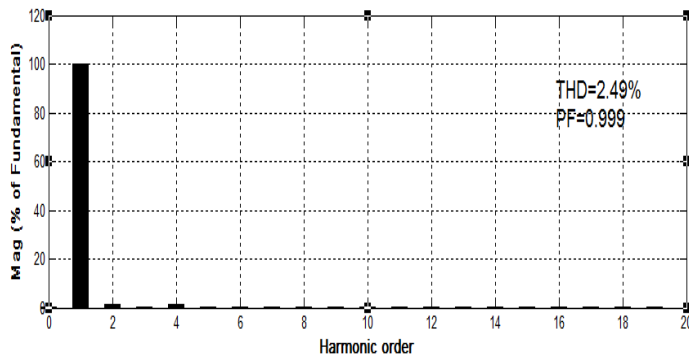
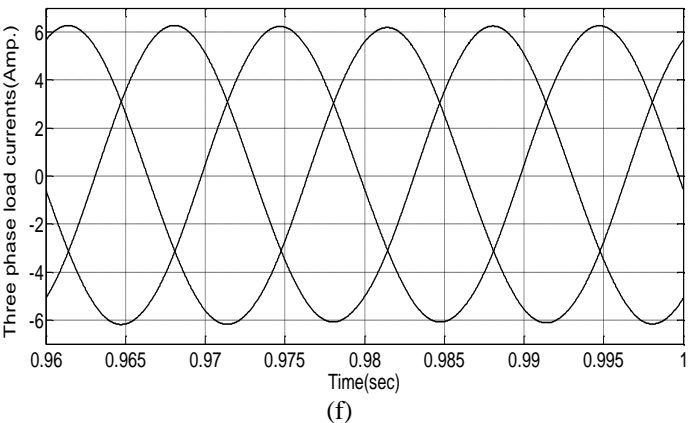
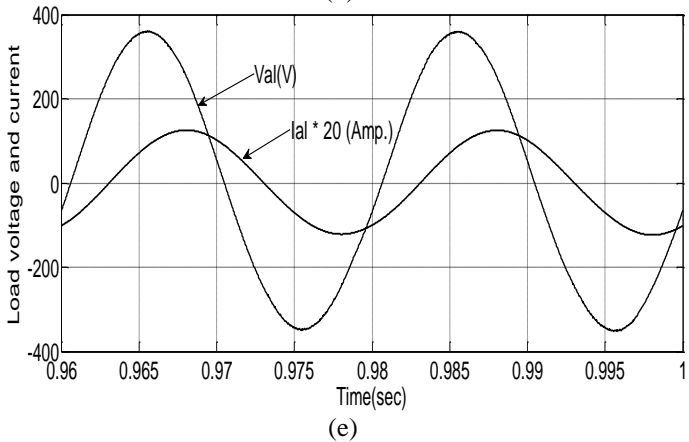
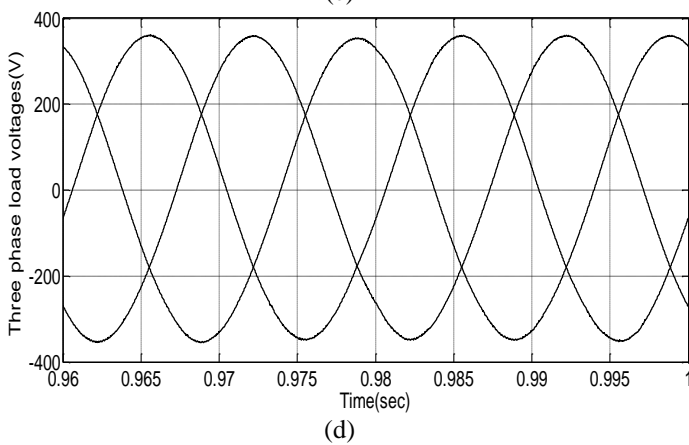
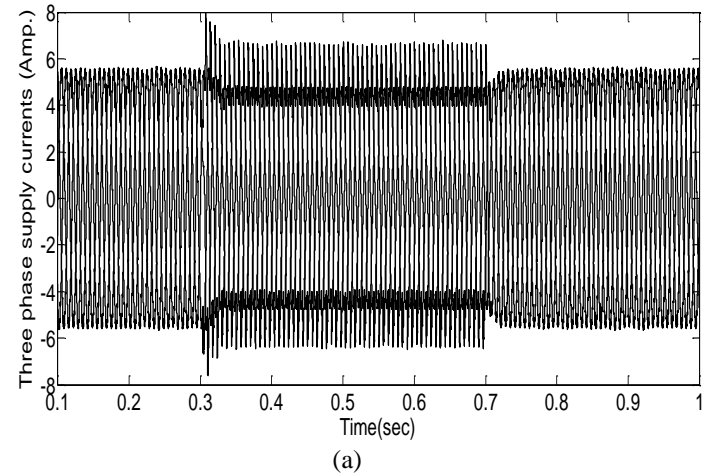

Fig.3 The steady state simulation results of the proposed circuit;(a) Supply voltage and current; (b) Three phase supply currents ; (c) Harmonics spectrum of supply current ;(d) Three phase load voltages; (e) Load voltage and current; (f) Three phase load currents; and (g) Input voltage and current for distorted supply voltage.

Other transient state results were obtained by  $\pm 34\%$  increasing in the load as shown in Fig. 4. In Fig. 4(a), a symmetrical three phase supply currents is presented and also the figure shows the change in current with load change (proportional relationship). Also, as shown in Fig. 4(b) shows the symmetrical three phase load current and it could be indicate from the figure, the change in the load current as it is increase when the load increase and vice versa. Fig. 4(c) indicates that RMS value of the load voltage ( $v_{al}$ ) has a high response back to the reference value during the load change ,so the figure shows that the circuit presents a high performance response during change in load .



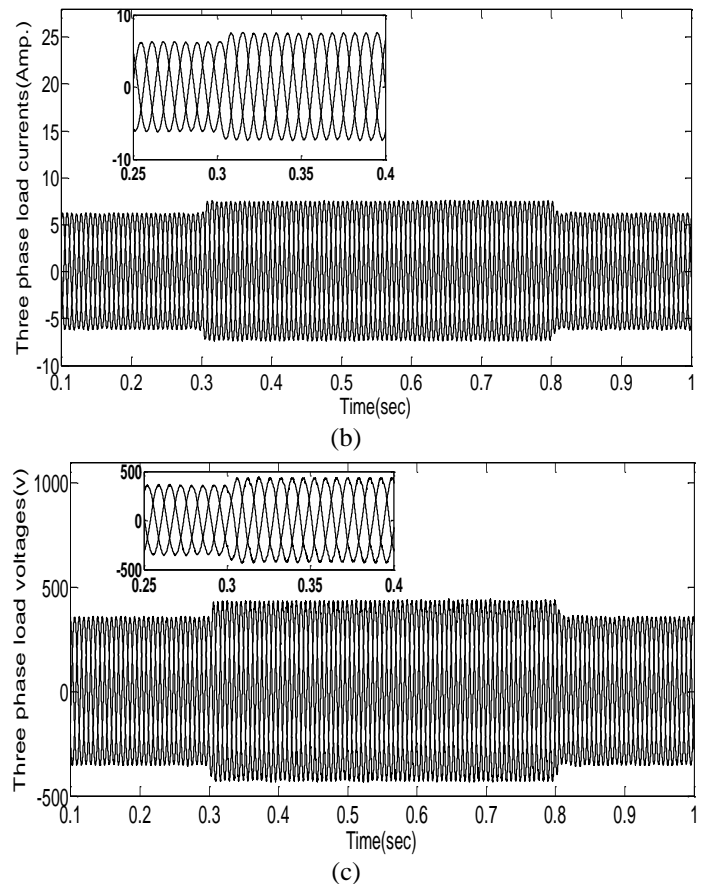
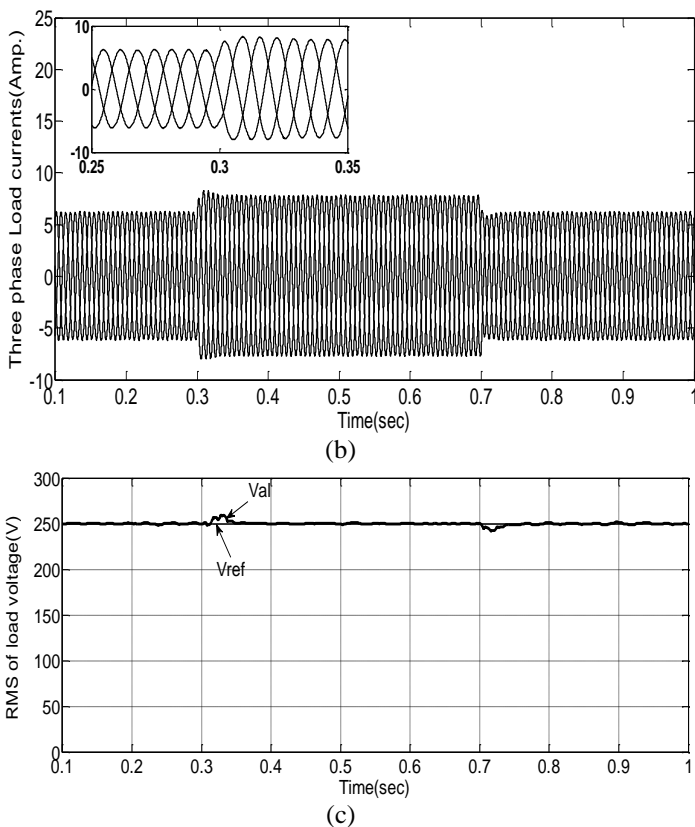

Fig.4 The transient state simulation results ( $\pm 34\%$  increase in load); (a) Three phase supply currents; (b) Three phase load currents; (c) RMS value of load voltage ( $v_{al}$ ).

Other transient state results were obtained by making a step change in the reference voltage from 250V to 300V then decreased to 250V again, as indicated in Fig. 5. In Fig. 5(a), the three phase supply currents and its change during reference voltage change are proportional relationship; Fig. 5(b) shows the three phase load current with a high quality waveform (no harmonics component) and approximately pure sine wave and the figure shows the variation with reference voltage change (proportional relationship), also, Fig. 5(c) shows a three phase load voltages and the figure indicates the variation of the load voltage during the change in the reference voltage; Fig. 5(d) shows the transient response of the RMS value of the load voltage ( $v_{al}$ ) during the step change of the reference voltage.

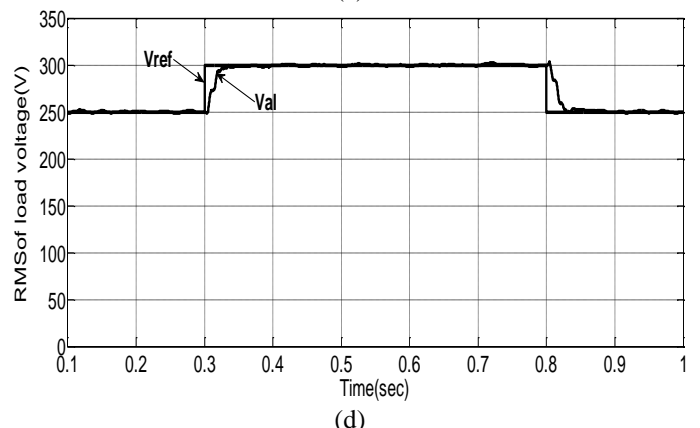
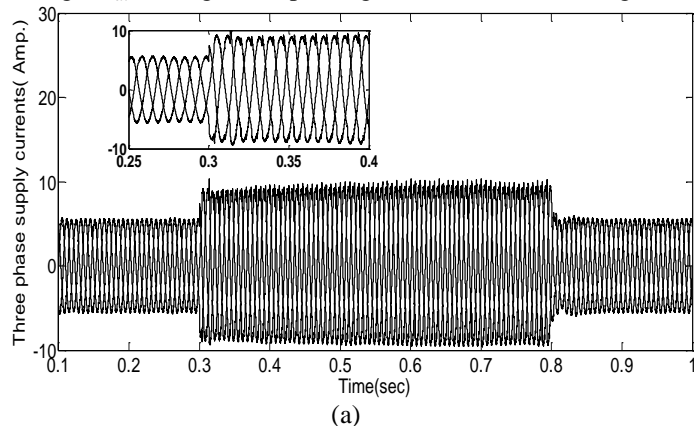
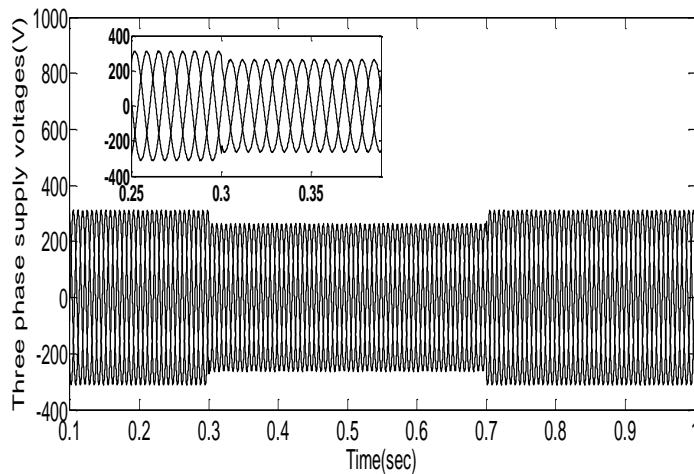
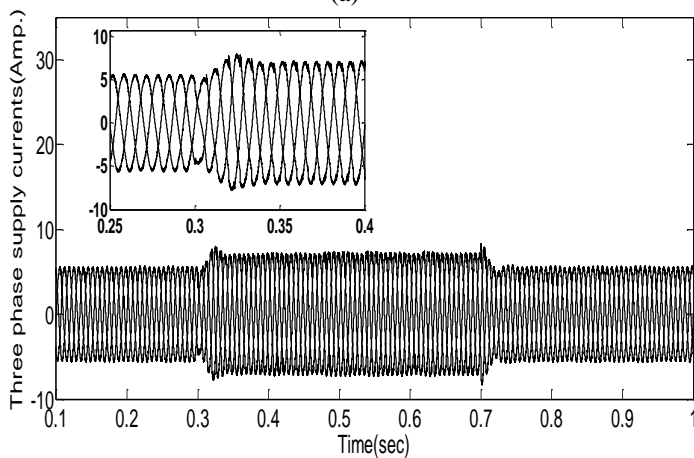

Fig. 5 The transient state simulation results ( $\pm 20\%$  step change in reference voltage); (a) Three phase supply currents; (b) Three phase load currents; (c) Three phase load voltages; (d) RMS value of load voltage ( $v_{al}$ ).

Fig.6 shows other transient state results were obtained by making a change in the supply voltage by  $\pm 25\%$  (220 to 170 and then increased to 220 again). Fig.6 shows if there is a drop in the supply voltage, what will be the reaction of the control circuit. Figures 6 (b, c, d and e) and the figures above show that the control methodology proposed a high quality response with a good performance at any change or disturbance in the circuit.



(a)



(b)

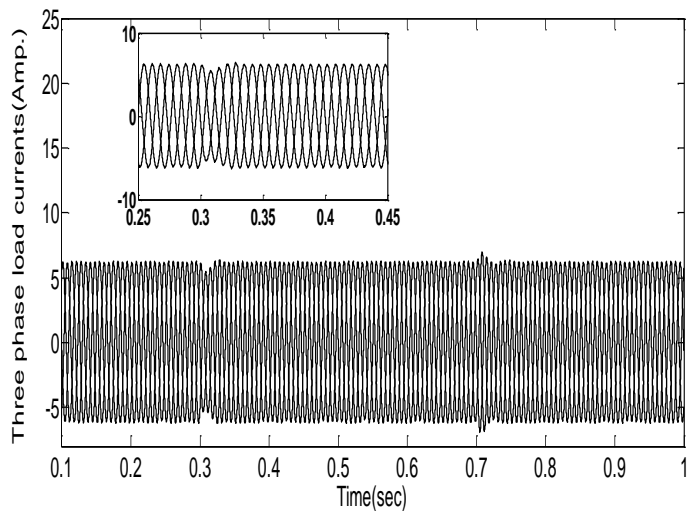

(c)

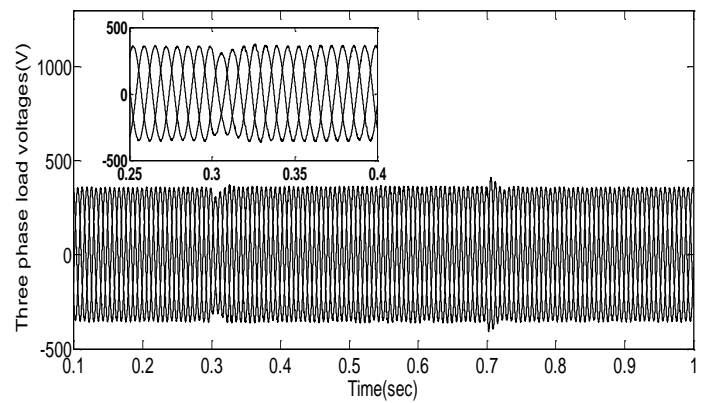

(d)

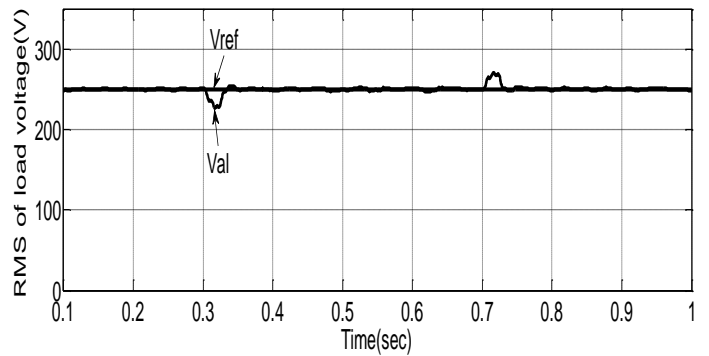

(e)

Fig.6 The transient state simulation results( $\pm 25\%$  step change in supply voltage); (a) Three phase supply voltages; (b) Three phase supply currents; (c) Three phase load currents; (d) Three phase load voltages; and (e) RMS value of load voltage( $v_{al}$ ).

## V. EXPERIMENTAL RESULTS

With the objective of evaluating the employed topology, a laboratory prototype is setup. The block diagram of the experimental setup and a real view of the complete control system are shown in Figs.7 and 8, respectively. The main components of the system which labeled as in Fig. 8 are listed in table I. The proposed new control is done on a digital signal processor board (DS1104) plugged into a computer. The control algorithm is executed by 'Matlab/simulink', and downloaded to the board through host computer. The output of the board is logic signals, which is fed to IGBTs through driver and isolation circuits. The system parameters are reported in the appendix.



Fig. 8 Experimental setup of the proposed circuit.

Label	Component	Label	Component
PC	Personal Computer	T	Fast recovery diodes
I	DSP Interface circuit	C	Capacitors
P.S	All other suppliers	L	Three phase inductance
P	Variable AC power supply	S	IGBT Switches
H	Voltage and current transducers	Z	Three phase RL load
B	Drive circuit	O	Oscilloscope

Table I

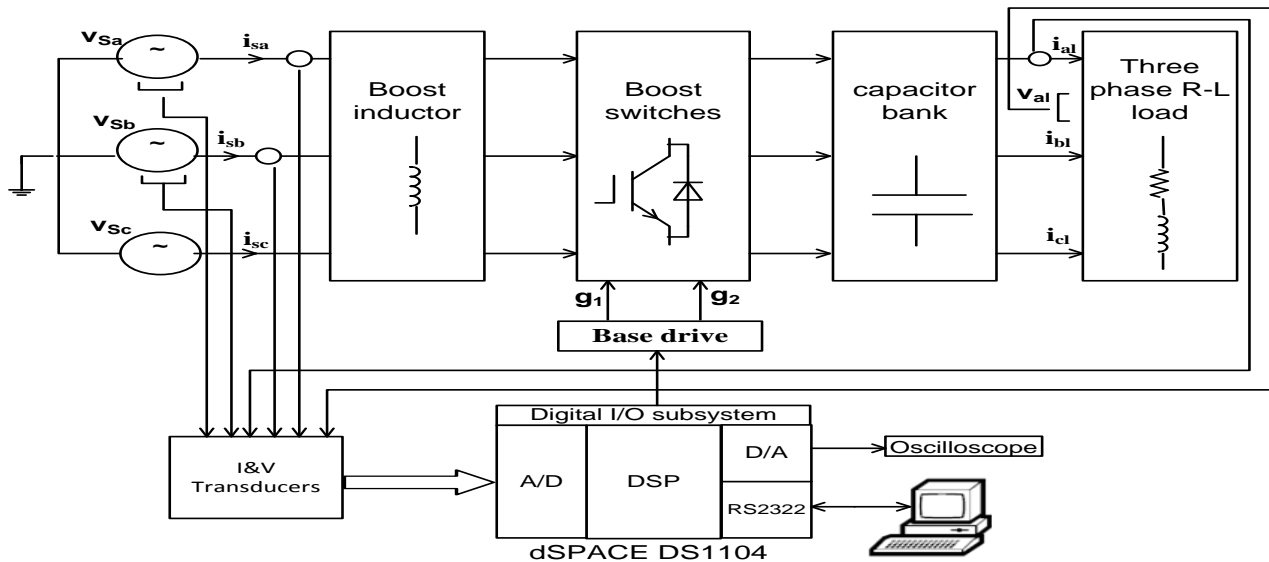
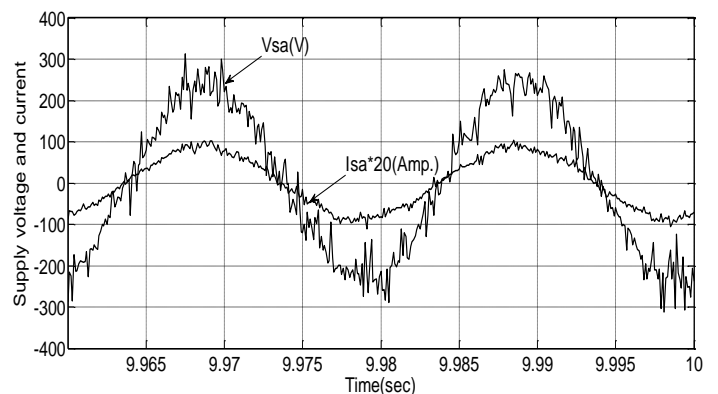

Fig.7 Block diagram of the experimental setup of the proposed circuit.

Figure 9 shows the steady-state experimental results of the proposed circuit using the new control methodology. It is shown that, the supply current has a nearly sinusoidal waveform and it is in phase with the input voltage as shown in fig.9 (a), also by comparing this figure with Fig. 9(b), it could be detecting the improving of the input power factor approximately near to unity. Figs.9(c) and 9(d) show the waveforms of the three phase supply currents and the harmonics spectrum of the supply current. It is observed that, the input current has a low THD of 8.83% with a high power factor of 0.996. Figs.9 (e) and 9(f) show the three phase load voltages and load currents, respectively; it is shown from figures the validity of the proposed circuit with the new control algorithm.



(a)



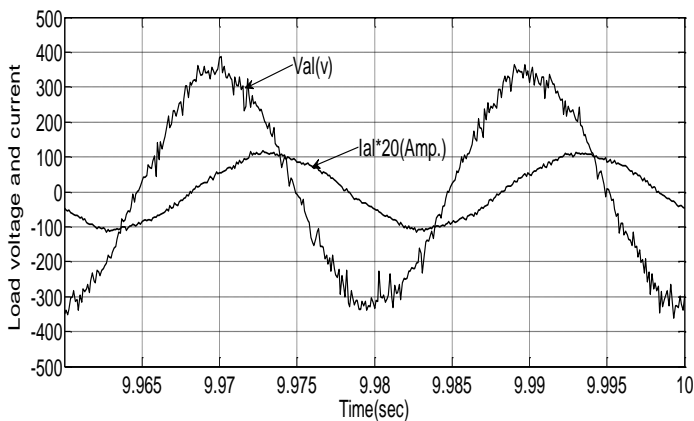

(b)

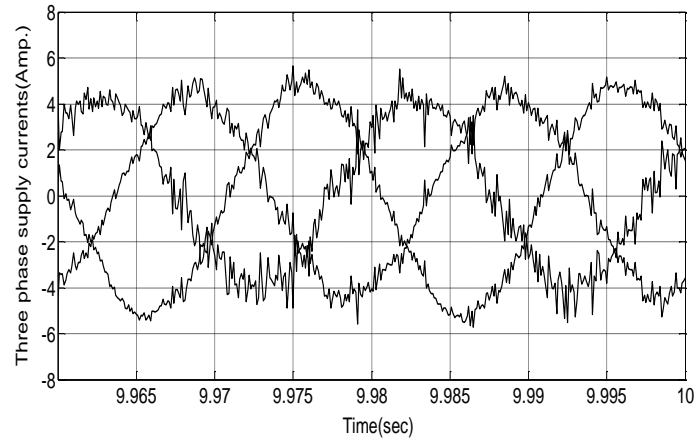

(c)

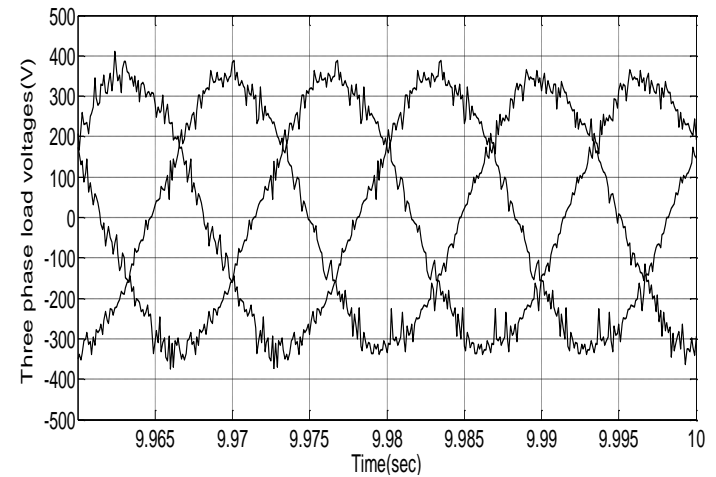
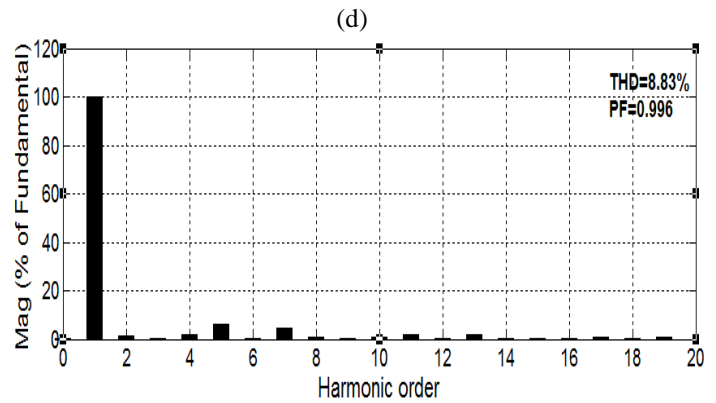

(e)

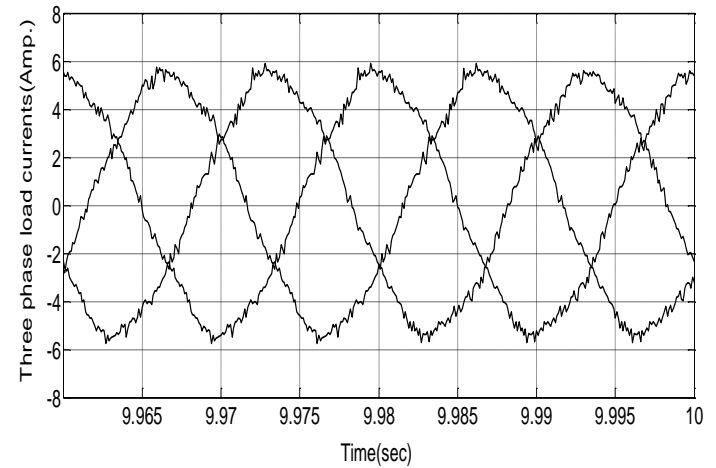

(f)

Fig. 9 The experimental results of the proposed circuit; (a) Supply voltage and current; (b) Load voltage and current; (c) Three phase supply currents; (d) Harmonics spectrum of supply current; (e) Three phase load voltages; and (f) Three phase load currents.

The experimental results of the three phase supply currents, three phase load currents, three phase load voltages and RMS value of load voltage due to a step change in reference voltage from 250V to 300V and return to 250V again are shown in Fig.10, respectively. It is shown that, the load voltage follows the desired reference voltage and hence, both the supply and load currents follow the variation in load voltage that ensures the high response of the proposed circuit.

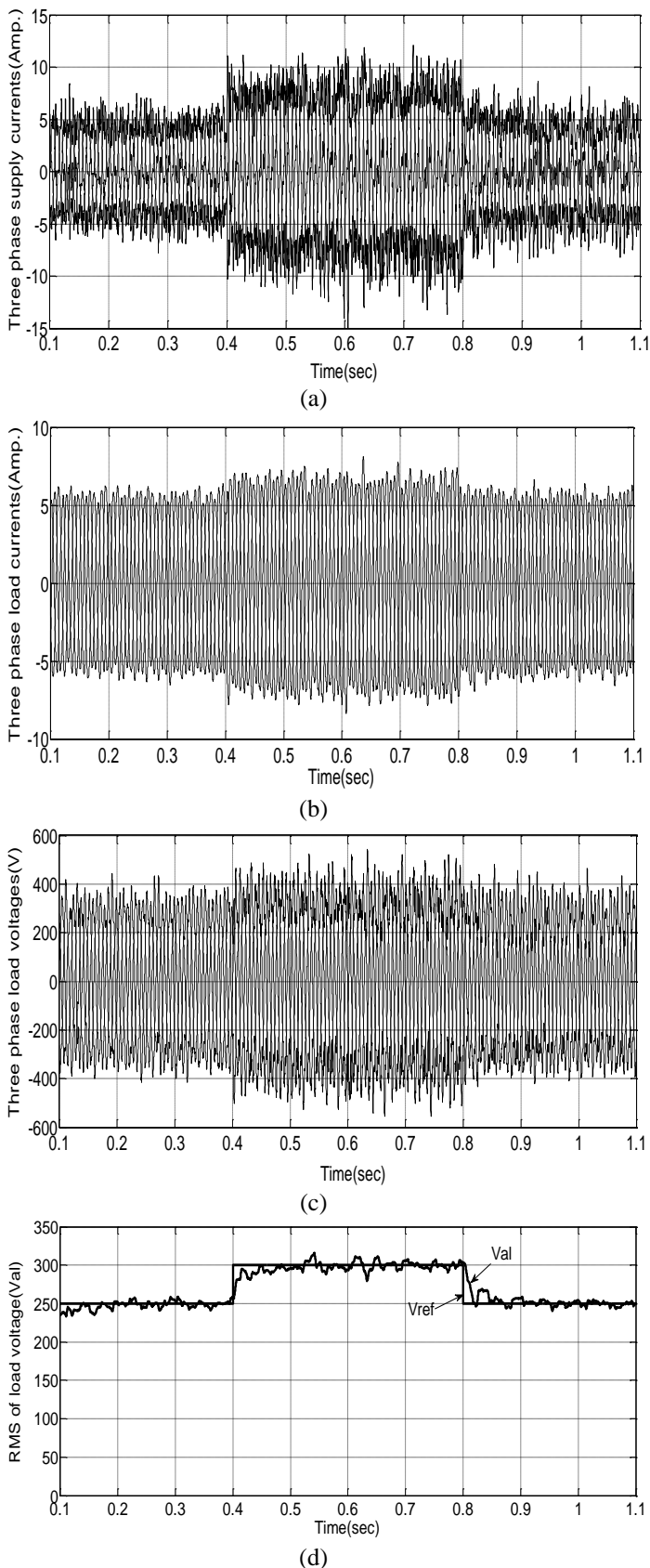

Fig. 10 The experimental results ( $\pm 20\%$  step change in reference voltage):(a) Three phase supply currents; (b) Three phase load currents; (c) Three phase load voltages; and (d) RMS value of load voltage( $v_{al}$ ).

There are slight differences between the simulation and experimental results because in simulation results the supply voltage has an ideal sine waveform, but in experimental results supply voltage is not ideal sine waveform. Also, the simulation results are done with sampling time  $1e^{-5}$  Sec. But, the experimental results are done with dSPACE (DS1104) (sampling time is  $1e^{-4}$  Sec.).

## VI. CONCLUSION

A new configuration for high performance three-phase AC-AC boost regulator is presented, also a new control scheme has been proposed. The proposed regulator has a nearly unity input power factor with low harmonics at both input and output side. The operation and modeling of the boost regulator have been described and analyzed. Since the regulator has a low number of switches used in the circuit (only four switches), the proposed approach provides a simple control design and implementation. Also, the proposed method is implemented using a zero-crossing processing, which allows a greater accuracy than other methods. The regulator is effectively an electronic step-up coreless transformer that restrains more harmonics of the output voltage compared to the conventional regulators. Input current of the proposed regulator flows continuously, therefore, the total harmonic distortion at the supply is very low. Also the proposed circuit presents good response and high efficiency.

## REFERENCE

- [1] D.H Jang and G.H Choe," Step-Up/Down AC Voltage Regulator Using transformer with Tap Changer and PWM AC Chopper," IEEE Transaction on Industrial Electronics, Vol. 45, No. 6, pp.905-911, 1998.
- [2] A.Gastli, and M. M. Ahmed," ANN-Based Soft Starting of Voltage-Controlled-Fed IM Drive System," IEEE Transaction on Energy Conversion, VOL. 20, NO. 3, pp.497-503, 2005.
- [3] G. Zenginobuz, I. Çadirci, M. Ermis, and C. Barlak, "Soft starting of large induction motors at constant current with minimized starting torque pulsations," IEEE Transaction on Industrial Applications., vol. 37, no. 5, pp. 137-144, 2001.
- [4] B. Han, S. Baek, and H. Kim, 'New Controller for Single-Phase PWM Converter without AC Source Voltage Sensor,' IEEE Transaction on Power Delivery, VOL. 20, NO. 2, pp.1453-1458, 2005.
- [5] B. N. Singh, A.Chandra, K. Al-Haddad and D. P. Kothar," A Review of Three-Phase Improved Power Quality AC-DC Converters," IEEE Transaction on Industrial Electronics, Vol. 51, No. 3, pp.641-660, 2004.
- [6] E. El-Bidweihy, K. Al-Bidweihy, M.S. Metwally and M. El-Eedwiehy, "Power Factor of AC Controllers for Inductive Loads," IEEE Transaction on Industrial Electronics, pp. 210-212, 1980.
- [7] V.V. Sastry, M. R. Prasad, and T. V. Sivakumar,"Optimal Soft Starting of Voltage-Controller-Fed IM Drive Based on Voltage across Thyristor," IEEE Transaction on Power Electronics, Vol. 12, No. 6, pp.1041-1051, 1997.

- [8] S. M. Hietpas and M. Naden, "Automatic Voltage Regulator Using an AC Voltage–Voltage Converter," IEEE Transaction on Industrial Applications, Vol. 36, No. 1, pp.33-38, 2000.
- [9] J.H. Youm, and B.H. Kwon,"Switching Technique for Current-Controlled AC-to-AC Converters," IEEE Transaction on Industrial Electronics, Vol. 46, No. 2, pp.309-318, 1999.
- [10] P. Midya, K. Haddad and Matt Miller," Buck or Boost Tracking Power Converter," IEEE Transaction on Power Electronics, Vol. 2, No. 4, pp.131-134, 2004.
- [11] O.García, J.A. Cobos, R. Prietoand J. Uceda,"Single Phase Power Factor Correction," IEEE Transaction on Power Electronics, Vol. 18, No. 3, pp.749-755, 2003.
- [12] J. Arrillaga and K. M. DuKe, "A static alternative to the transformer on-load tap changer", IEEE Transaction on Power Apparatus and System, no.1, pp.86-91, 1980.
- [13] A. E. Lashine, "A thyristorized saturable reactor with self excitation", Electric Machines and Power Systems, USA, vol.24, no.4, pp.437-449, 1996.
- [14] R. O. Caceres, and I. Barbi, "A Boost DC–AC Converter: Analysis, Design, and Experimentation," IEEE Transaction on Power Electronics, Vol. 14, No.1, pp.134-141, 1999.
- [15] J.W. Kolar, T. Friedli, J. Rodriguez and P. W. Wheeler," Review of Three Phase PWM AC–AC Converter Topologies," IEEE Transaction on Industrial Electronics, Vol. 58, No. 11, pp.4988-5006, 2011.
- [16] T. B. Soeiro, C. A. Petry, J. d. Fagundes and I. Barbi," Direct AC–AC Converters Using Commercial Power Modules Applied to Voltage Restorers," IEEE Transaction on Industrial Electronics, Vol. 58, No.1, pp.278-288, 2011.
- [17] A-R.A.M. Makky, N.A. Ahmed, H. Emad and A.C. El-Zohri," Voltage controller fed single-phase induction motor with power factor improvement employing modified phase angle control technique," in Conf. Proc. MEPCON03, pp. 623–628, Minoufiya, Egypt, 2003.
- [18] D. M. Divan, "Inverter topologies and control techniques for sinusoidal output power supplies", IEEE/APEC Conference record, vol. 1, pp.81-87, 1991.
- [19] M. Kang, P. N. Enjeti and I. J Pitel, "Analysis and design of electronic transformers for electric power distribution system", IEEE-IAS Annual Meeting, New Orleans, Louisiana, pp. 1689-1694, October 1997.
- [20] T. S. Radwan, A. E. Lashine and M. A. Rahman," A New Three-Phase Boost-Type Voltage Regulator with Unity Input Power Factor" T. IEE Japan, Vol. 120-D, No. 12, pp.1501-1507, 2000.

#### Appendix A

The simulation and the experimental results for the proposed method are taken with the following specifications;

$$V_{sa} = V_{sb} = V_{sc} = 220 \text{ V}$$

$$L_{Ba} = L_{Bb} = L_{Bc} = 15 \text{ mH}$$

$$R_{Ba} = R_{Bb} = R_{Bc} = 1.5 \Omega$$

$$C_a = C_b = C_c = 12 \mu\text{F}$$

Load side; three phase balanced R-L with  $R_L = 40 \Omega$  and  $L_L = 130 \text{ mH}$ .